

# SERIES 3 HEAVY DUTY (COLD FORGED)

Capacities to 1500 lbs.

## Standard Features

- **Top Plate** - Extra-thick  $\frac{5}{16}$ " carbon steel, heat treated for added strength and durability in severe service
- **Yoke Base** - Cold forged  $\frac{1}{4}$ " steel, notched for optional 4 position lock
- **Swivel Bearing Raceways** - Main load race diameter is  $3\frac{1}{4}$ " with fully hardened  $\frac{7}{16}$ " ball bearings. Both upper and lower raceways are burnished to resist wear; lower is also heat treated for added life
- **Formed Swivel Legs** - Cold forged from  $\frac{1}{4}$ " steel for added strength, then welded to the yoke base

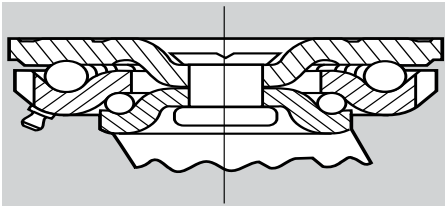

- **Large King Pin** - An extra heavy  $\frac{3}{4}$ " hardened king pin assembly aligns raceways perfectly
- **Wheel Bearings** - Roller bearings are standard for all wheel sizes
- **Pressure Lubrication** - Fittings are standard for both swivel raceway and wheel bearings
- **Finish** - Corrosion resistant zinc

## Standard Top Plate

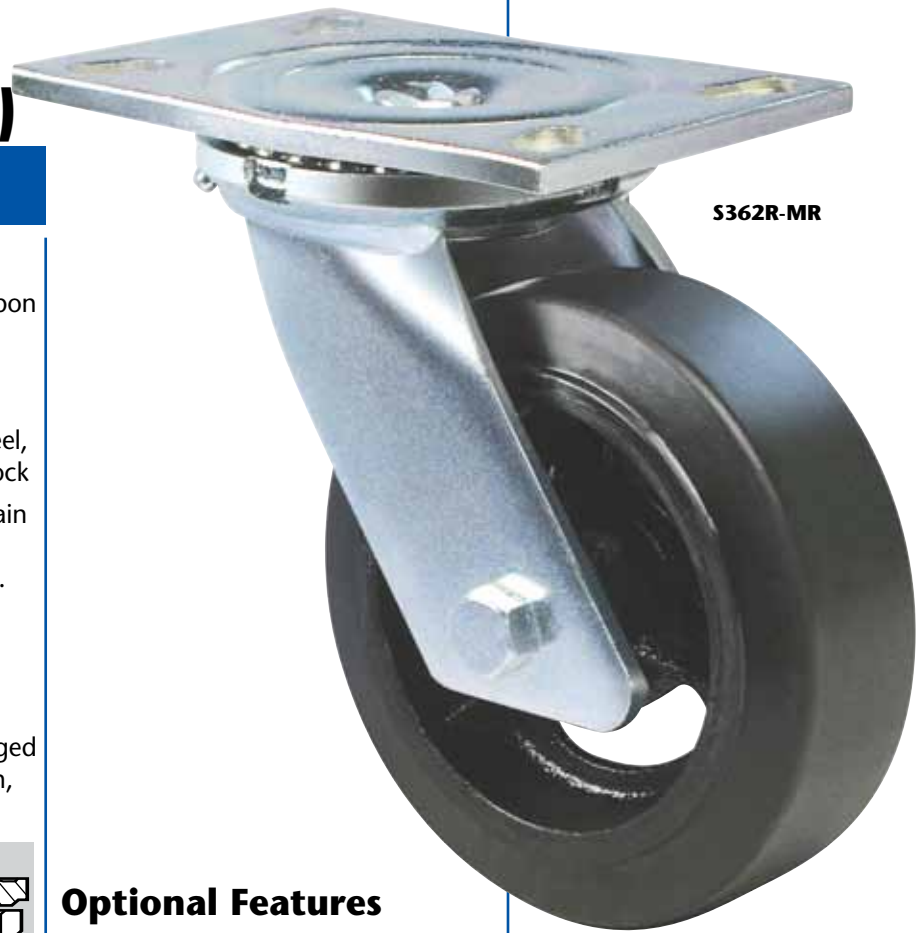
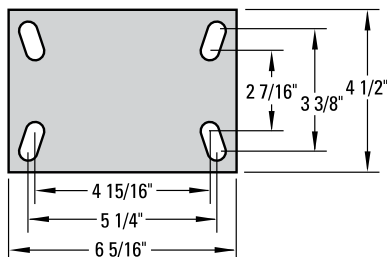

S362R-MR

## Optional Features

- **Wheel Brake Cam-Style** - (Suffix **-WB**)



- **4 Position Swivel Lock** - (Suffix **-SL**) Field Installable



Swivel lock plunger may be ordered separately (Part No. **3SL**)



R362R-KT

Wheel Specifications						Caster Specifications						Part Number						
Dia. "A" Inches (mm)	Tread Inches (mm)	Wheel Composition	Ref. to Page	Bearing Type	Axle Dia. Inches (mm)	Load Capacity lbs. (KGS)	Overall Height "B" Inches (mm)	Swivel Radius Inches (mm)	Attach. Bolt Inches (mm)	Approx. Shipping Wt.		Swivel Caster	Rigid Caster					
										Swivel lbs. (KGS)	Rigid lbs. (KGS)							
4 (102)	2 (50)	Cast Iron	86	Roller	1/2 (13)	800 (360)	5 5/8 (143)	3 1/2 (89)	1/2 (13)	8.5 (3.8)	8.0 (3.6)	S342R-SS	R342R-SS					
		Phenolic	82	Roller		800 (360)				6.0 (2.7)	5.5 (2.5)	S342R-PH	R342R-PH					
		Mold-on Rubber (Cast Iron Core)	74	Roller		350 (157)				8.5 (3.8)	8.0 (3.6)	S342R-MR	R342R-MR					
		Polyurethane (Cast Iron Core)	78	Roller		700 (315)				8.5 (3.8)	8.0 (3.6)	S342R-PI	R342R-PI					
		Polyurethane (Alum. Core)	75	Roller		700 (315)				6.5 (2.9)	6.0 (2.7)	S342R-PA	R342R-PA					
		Solid Urethane	77	Roller		700 (315)				6.5 (2.9)	6.0 (2.7)	S342R-KT	R342R-KT					
		Polyurethane (Polyolefin Core)	80	Roller		700 (315)				6.0 (2.7)	5.5 (2.5)	S342R-PP	R342R-PP					
		Polyolefin (Blk)	81	Roller		450 (202)				5.5 (2.5)	5.0 (2.3)	S342R-PB	R342R-PB					
	Polyolefin (Wt)	81	Delrin	450 (202)		5.5 (2.5)				5.0 (2.3)	S342D-PW	R342D-PW						
	1 1/2 (38)	Forged Steel	88	Roller		1400 (630)				8.5 (3.8)	8.0 (3.6)	S341R-FS	R341R-FS					
5 (127)	2 (50)	Cast Iron	86	Roller	1/2 (13)	1000 (450)	6 1/2 (165)	4 7/8 (124)	1/2 (13)	8.8 (4.0)	8.3 (3.7)	S352R-SS	R352R-SS					
		Phenolic	82	Roller		1000 (450)				6.5 (3.0)	6.0 (2.7)	S352R-PH	R352R-PH					
		Mold-on Rubber (Cast Iron Core)	74	Roller		350 (157)				8.8 (4.0)	8.3 (3.7)	S352R-MR	R352R-MR					
		Polyurethane (Cast Iron Core)	78	Roller		900 (405)				8.8 (4.0)	8.3 (3.7)	S352R-PI	R352R-PI					
		Polyurethane (Alum. Core)	75	Roller		1000 (450)				7.0 (3.2)	6.5 (3.0)	S352R-PA	R352R-PA					
		Solid Urethane	77	Roller		1000 (450)				7.0 (3.2)	6.5 (3.0)	S352R-KT	R352R-KT					
		Polyurethane (Polyolefin Core)	80	Roller		750 (337)				6.5 (3.0)	6.0 (2.7)	S352R-PP	R352R-PP					
		Santoprene (Polyolefin Core)	72	Roller		450 (202)				6.5 (3.0)	6.0 (2.7)	S352R-SP	R352R-SP					
		Polyolefin (Blk)	81	Roller		650 (292)				6.0 (2.7)	5.5 (2.5)	S352R-PB	R352R-PB					
		Polyolefin (Wt)	81	Delrin		600 (270)				6.0 (2.7)	5.5 (2.5)	S352D-PW	R352D-PW					
		Forged Steel	88	Roller		1400 (630)				8.8 (4.0)	8.3 (3.7)	S352R-FS	R352R-FS					
		6 (152)	2 (50)	Cast Iron		86				Roller	1/2 (13)	1200 (540)	7 1/2 (190)	5 3/8 (136)	1/2 (13)	9.2 (4.1)	8.2 (3.7)	S362R-SS
	Phenolic			82		Roller				1200 (540)		7.2 (3.2)				6.2 (2.8)	S362R-PH	R362R-PH
Mold-on Rubber (Cast Iron Core)	74			Roller	500 (225)	9.2 (4.1)	8.2 (3.7)	S362R-MR	R362R-MR									
Polyurethane (Cast Iron Core)	78			Roller	1200 (540)	9.2 (4.1)	8.2 (3.7)	S362R-PI	R362R-PI									
Polyurethane (Alum. Core)	75			Roller	1200 (540)	7.7 (3.5)	6.7 (3.0)	S362R-PA	R362R-PA									
Solid Urethane	77			Roller	1200 (540)	7.2 (3.2)	6.5 (2.9)	S362R-KT	R362R-KT									
Polyurethane (Polyolefin Core)	80			Roller	1200 (540)	7.2 (3.2)	6.2 (2.8)	S362R-PP	R362R-PP									
Santoprene (Polyolefin Core)	72			Roller	550 (247)	7.2 (3.2)	6.2 (2.8)	S362R-SP	R362R-SP									
Polyolefin (Blk)	81			Roller	700 (315)	6.7 (3.0)	5.7 (2.6)	S362R-PB	R362R-PB									
Polyolefin (Wt)	81			Delrin	650 (292)	6.7 (3.0)	5.7 (2.6)	S362D-PW	R362D-PW									
Forged Steel	88			Roller	1500 (675)	9.5 (4.3)	8.5 (3.8)	S362R-FS	R362R-FS									
2 1/2 (63)	Cast Iron			86	Roller	1500 (675)	11.2 (5.0)	10.2 (4.6)	S3625R-SS	R3625R-SS								
	Phenolic		82	Roller	1500 (675)	9.2 (4.1)	8.2 (3.7)	S3625R-PH	R3625R-PH									
	Mold-on Rubber (Cast Iron Core)		74	Roller	600 (270)	11.2 (5.0)	10.2 (4.6)	S3625R-MR	R3625R-MR									
	Polyurethane (Cast Iron Core)		78	Roller	1500 (675)	11.2 (5.0)	10.2 (4.6)	S3625R-PI	R3625R-PI									

8" AND 10" DIAMETERS ARE ON THE NEXT PAGE

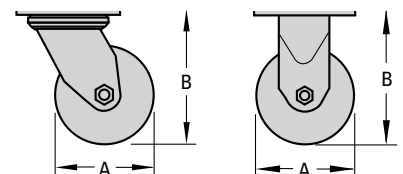

# SERIES 3 (CONTINUED) HEAVY DUTY (COLD FORGED)

Wheel Specifications						Caster Specifications						Part Number						
Dia. "A" Inches (mm)	Tread Inches (mm)	Wheel Composition	Ref. to Page	Bearing Type	Axle Dia. Inches (mm)	Load Capacity lbs. (KGS)	Overall Height "B" Inches (mm)	Swivel Radius Inches (mm)	Attach. Bolt Inches (mm)	Approx. Shipping Wt.		Swivel Caster	Rigid Caster					
										Swivel lbs. (KGS)	Rigid lbs. (KGS)							
8 (203)	2 (50)	Cast Iron	86	Roller	1/2 (13)	1400 (630)	10 1/8 (257)	6 3/8 (162)	1/2 (13)	14.0 (6.3)	12.0 (5.4)	S382R-SS	R382R-SS					
		Phenolic	82	Roller		1400 (630)				10.0 (4.5)	8.0 (3.6)	S382R-PH	R382R-PH					
		Mold-on Rubber (Cast Iron Core)	74	Roller		600 (270)				14.0 (6.3)	12.0 (5.4)	S382R-MR	R382R-MR					
		Polyurethane (Cast Iron Core)	78	Roller		1400 (630)				14.0 (6.3)	12.0 (5.4)	S382R-PI	R382R-PI					
		Polyurethane (Alum. Core)	75	Roller		1400 (630)				11.0 (5.0)	9.0 (4.1)	S382R-PA	R382R-PA					
		Solid Urethane	77	Roller		1200 (540)				11.0 (5.0)	9.0 (4.1)	S382R-KT	R382R-KT					
		Polyurethane (Polyolefin Core)	80	Roller		1000 (450)				11.0 (5.0)	9.0 (4.1)	S382R-PP	R382R-PP					
		Santoprene (Polyolefin Core)	72	Roller		700 (315)				11.0 (5.0)	9.0 (4.1)	S382R-SP	R382R-SP					
		Polyolefin (Blk)	81	Roller		800 (360)				10.0 (4.5)	8.0 (3.6)	S382R-PB	R382R-PB					
		Polyolefin (Wt)	81	Delrin		750 (337)				10.0 (4.5)	8.0 (3.6)	S382D-PW	R382D-PW					
	2 1/2 (63)	Cast Iron	86	Roller		1500 (675)				16.0 (7.2)	13.0 (5.9)	S3825R-SS	R3825R-SS					
		Phenolic	82	Roller		1500 (675)				12.0 (5.4)	10.0 (4.5)	S3825R-PH	R3825R-PH					
		Mold-on Rubber (Cast Iron Core)	74	Roller		800 (360)				15.0 (6.8)	13.0 (5.9)	S3825R-MR	R3825R-MR					
		Polyurethane (Cast Iron Core)	78	Roller		1500 (675)				15.0 (6.8)	13.0 (5.9)	S3825R-PI	R3825R-PI					
		10 (254)	2 (50)	Cast Iron		86				Roller	1400 (630)	11 1/2 (292)	7 3/8 (187)	1/2 (13)	20.0 (9.0)	16.0 (7.2)	S3102R-SS	R3102R-SS
				Mold-on Rubber (Cast Iron Core)		74				Roller	600 (270)				18.0 (8.1)	14.0 (6.3)	S3102R-MR	R3102R-MR
Polyurethane (Cast Iron Core)	78			Roller	1400 (630)	15.0 (6.8)	11.0 (5.0)	S3102R-PI	R3102R-PI									
2 1/2 (63)	Cast Iron		86	Roller	1500 (675)	22.0 (9.9)	18.0 (8.1)	S31025R-SS	R31025R-SS									
	Phenolic		82	Roller	1500 (675)	13.0 (5.9)	9.0 (4.1)	S31025R-PH	R31025R-PH									
	Mold-on Rubber (Cast Iron Core)		74	Roller	800 (360)	20.0 (9.0)	16.0 (7.2)	S31025R-MR	R31025R-MR									
	Polyurethane		78	Roller	1500 (675)	20.0 (9.0)	16.0 (7.2)	S31025R-PI	R31025R-PI									

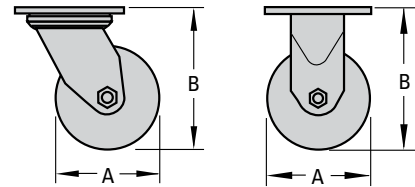

# SERIES 4 HEAVY DUTY (COLD FORGED)

Capacities to 1800 lbs.

## Standard Features

- **Top Plate** - 1/4" cold forged
- **Swivel Assembly** - Large diameter double ball bearing. Heat treated raceways
- **Legs** - 3/8" thick formed, welded inside and out

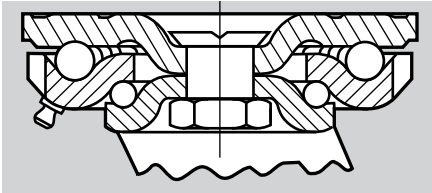

- **King Pin** - 3/4" heat treated bolt and nut
- **Axle** - 3/4" hollow axle with grease zerk
- **Finish** - Corrosion resistant zinc

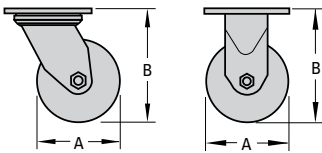

S4825R-PI



R4625R-PH



Thumb Screw Brake

## Optional Features

- **Thumb Screw Wheel Brake** - (Suffix -WB)
- **Delrin Bearing** - (Change R to D)  
Example: S4625D-PH
- **Sealed Wheel** - (Suffix -SW)
- **Swivel Lock** - (Suffix -SL)

## Standard Top Plate

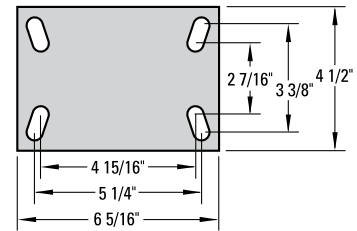

Wheel Specifications					Caster Specifications					Part Number			
Dia. "A" Inches (mm)	Tread Inches (mm)	Wheel Composition	Ref. to Page	Bearing Type	Axle Dia. Inches (mm)	Load Capacity lbs. (KGS)	Overall Height "B" Inches (mm)	Swivel Radius Inches (mm)	Attach. Bolt Inches (mm)	Approx. Shipping Wt.		Swivel Caster	Rigid Caster
										Swivel lbs. (KGS)	Rigid lbs. (KGS)		
6 (152)	2 1/2 (63)	Cast Iron	86	Roller	3/4 (19)	1500 (675)	7 1/2 (190)	5 1/4 (133)	1/2 (13)	11.2 (5.0)	10.2 (4.6)	S4625R-SS	R4625R-SS
		Phenolic	82	Roller		1500 (675)				9.2 (4.1)	8.2 (3.7)	S4625R-PH	R4625R-PH
		Mold-on Rubber (Cast Iron Core)	74	Roller		540 (243)				11.2 (5.0)	10.2 (4.6)	S4625R-MR	R4625R-MR
		Polyurethane (Cast Iron Core)	78	Roller		1500 (675)				11.2 (5.0)	10.2 (4.6)	S4625R-PI	R4625R-PI
8 (203)	2 1/2 (63)	Cast Iron	86	Roller	3/4 (19)	1500 (675)	10 1/8 (257)	6 1/4 (158)	1/2 (13)	16.0 (7.2)	13.0 (5.9)	S4825R-SS	R4825R-SS
		Phenolic	82	Roller		1500 (675)				12.0 (5.4)	10.0 (4.5)	S4825R-PH	R4825R-PH
		Mold-on Rubber (Cast Iron Core)	74	Roller		670 (302)				15.0 (6.8)	13.0 (5.9)	S4825R-MR	R4825R-MR
		Polyurethane (Cast Iron Core)	78	Roller		1500 (675)				15.0 (6.8)	13.0 (5.9)	S4825R-PI	R4825R-PI
10 (254)	2 1/2 (63)	Cast Iron	86	Roller	3/4 (19)	1800 (810)	11 1/2 (292)	7 1/4 (184)	1/2 (13)	18.0 (8.1)	16.0 (7.2)	S41025R-SS	R41025R-SS
		Phenolic	82	Roller		1800 (810)				13.0 (5.0)	11.0 (5.0)	S41025R-PH	R41025R-PH
		Mold-on Rubber (Cast Iron Core)	74	Roller		840 (378)				18.0 (8.1)	16.0 (7.2)	S41025R-MR	R41025R-MR
		Polyurethane (Cast Iron Core)	78	Roller		1800 (810)				18.0 (8.1)	16.0 (7.2)	S41025R-PI	R41025R-PI
12 (305)	2 1/2 (63)	Cast Iron	86	Roller	3/4 (19)	1800 (810)	13 1/2 (343)	8 1/4 (209)	1/2 (13)	22.0 (9.9)	19.0 (8.6)	S41225R-SS	R41225R-SS
		Phenolic	82	Roller		1800 (810)				18.0 (8.1)	15.0 (6.8)	S41225R-PH	R41225R-PH
		Mold-on Rubber (Cast Iron Core)	74	Roller		840 (378)				21.0 (9.5)	18.0 (8.1)	S41225R-MR	R41225R-MR
		Polyurethane (Cast Iron Core)	78	Roller		1800 (810)				21.0 (9.5)	18.0 (8.1)	S41225R-PI	R41225R-PI

# SERIES 5 HEAVY DUTY (HOT FORGED)

Capacities to 1500 lbs.

## Standard Features

- **Top Plate/Yoke Base** - SAE-1045 drop forged steel
- **Swivel Assembly** - Double ball bearing design. Machined thrust raceway

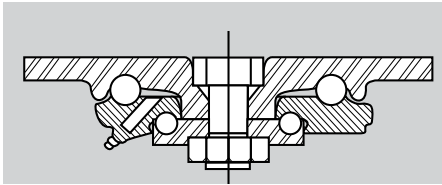

- **King Pin** - 3/4" heat treated bolt and nut
- **Legs** - 1/4" thick formed and welded
- **Finish** - Corrosion resistant zinc
- **Lubrication Fittings**

## Standard Top Plate

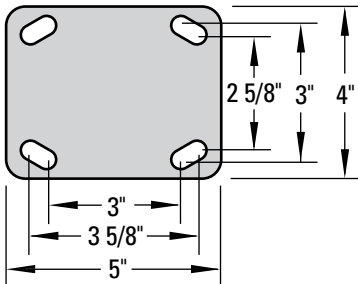

## Optional Features

- **Swivel Bearing Grease Seal** (Suffix -GS)
- **Wheel Brake** - (Suffix -WB) cam style
- **4-Position Swivel Lock** (Suffix -SL)



**APPLICATIONS:**  
Ideally suited for medium heavy duty requirements where loads are subject to frequent shock or impact.

Bolt pattern matches the Series 1 medium heavy duty for easy upgrade without re-drilling bolt holes.

S562R-KT



Cam Style Wheel Brake



R552R-PH



Wheel Specifications						Caster Specifications						Part Number	
Dia. "A" Inches (mm)	Tread Inches (mm)	Wheel Composition	Ref. to Page	Bearing Type	Axle Dia. Inches (mm)	Load Capacity lbs. (KGS)	Overall Height "B" Inches (mm)	Swivel Radius Inches (mm)	Attach. Bolt Inches (mm)	Approx. Shipping Wt.		Swivel Caster	Rigid Caster
										Swivel lbs. (KGS)	Rigid lbs. (KGS)		
4 (102)	2 (50)	Grey Iron (Heavy Duty)	85	Roller	1/2 (13)	400 (185)	5 5/8 (143)	3 7/16 (87)	3/8 (10)	10.0 (4.5)	6.3 (2.8)	S542R-GI	R542R-GI
		Phenolic	82	Roller		800 (360)				8.0 (3.6)	6.0 (2.7)	S542R-PH	R542R-PH
		Mold-on Rubber (Cast Iron Core)	74	Roller		350 (158)				8.0 (3.6)	6.0 (2.7)	S542R-MR	R542R-MR
		Polyurethane (Cast Iron Core)	78	Roller		700 (315)				8.0 (3.6)	6.0 (2.7)	S542R-PI	R542R-PI
		Polyurethane (Alum. Core)	75	Roller		800 (360)				7.5 (3.4)	5.0 (2.3)	S542R-PA	R542R-PA
		Solid Urethane	77	Roller		800 (360)				7.5 (3.4)	5.0 (2.3)	S542R-KT	R542R-KT
		Severe Duty Polyurethane	79	Roller		800 (360)				10.0 (4.5)	8.0 (3.6)	S542R-PS	R542R-PS
	1 1/2 (38)	Forged Steel	88	Roller		1400 (630)				10.0 (4.5)	8.0 (3.6)	S541R-FS	R541R-FS
5 (127)	2 (50)	Grey Iron (Heavy Duty)	85	Roller	1/2 (13)	1000 (450)	6 1/2 (165)	4 5/16 (110)	3/8 (10)	12.0 (5.4)	10.0 (4.5)	S552R-GI	R552R-GI
		Phenolic	82	Roller		1000 (450)				9.0 (4.1)	7.0 (3.0)	S552R-PH	R552R-PH
		Mold-on Rubber (Cast Iron Core)	74	Roller		350 (158)				9.0 (4.1)	7.0 (3.0)	S552R-MR	R552R-MR
		Polyurethane (Cast Iron Core)	78	Roller		1000 (450)				9.0 (4.1)	7.0 (3.0)	S552R-PI	R552R-PI
		Polyurethane (Alum. Cor)	75	Roller		1000 (450)				8.5 (3.8)	6.5 (2.9)	S552R-PA	R552R-PA
		Solid Urethane	77	Roller		1000 (450)				8.5 (3.8)	6.5 (2.9)	S552R-KT	R552R-KT
		Severe Duty Polyurethane	79	Roller		1100 (495)				12.0 (5.4)	10.0 (4.5)	S552R-PS	R552R-PS
		Forged Steel	88	Roller		1500 (675)				12.0 (5.4)	10.0 (4.5)	S552R-FS	R552R-FS
6 (152)	2 (50)	Grey Iron (Heavy Duty)	85	Roller	1/2 (13)	1200 (540)	7 1/2 (191)	5 1/4 (133)	3/8 (10)	13.0 (5.9)	11.0 (5.0)	S562R-GI	R562R-GI
		Phenolic	82	Roller		1200 (540)				10.0 (4.5)	8.0 (3.6)	S562R-PH	R562R-PH
		Mold-on Rubber (Cast Iron Core)	74	Roller		410 (185)				12.0 (5.4)	10.0 (4.5)	S562R-MR	R562R-MR
		Polyurethane (Cast Iron Core)	78	Roller		1200 (540)				12.0 (5.4)	10.0 (4.5)	S562R-PI	R562R-PI
		Polyurethane (Alum. Core)	75	Roller		1200 (540)				11.0 (5.0)	9.0 (3.6)	S562R-PA	R562R-PA
		Solid Urethane	77	Roller		1200 (540)				11.0 (5.0)	9.0 (3.6)	S562R-KT	R562R-KT
		Severe Duty Polyurethane	79	Roller		1200 (540)				13.0 (5.9)	11.0 (5.0)	S562R-PS	R562R-PS
		Forged Steel	88	Roller		1500 (675)				13.0 (5.9)	11.0 (5.0)	S562R-FS	R562R-FS
8 (203)	2 (50)	Grey Iron (Heavy Duty)	85	Roller	1/2 (13)	1400 (630)	10 1/8 (257)	6 1/4 (159)	3/8 (10)	16.0 (7.2)	14.0 (6.3)	S582R-GI	R582R-GI
		Phenolic	82	Roller		1400 (630)				11.0 (5.0)	9.0 (3.6)	S582R-PH	R582R-PH
		Mold-on Rubber (Cast Iron Core)	74	Roller		500 (225)				13.0 (5.9)	11.0 (5.0)	S582R-MR	R582R-MR
		Polyurethane (Cast Iron Core)	78	Roller		1400 (630)				13.0 (5.9)	11.0 (5.0)	S582R-PI	R582R-PI
		Polyurethane (Alum. Core)	75	Roller		1400 (630)				12.0 (5.4)	10.0 (4.5)	S582R-PA	R582R-PA
		Solid Urethane	77	Roller		1200 (540)				12.0 (5.4)	10.0 (4.5)	S582R-KT	R582R-KT
		Severe Duty Polyurethane	79	Roller		1500 (675)				16.0 (7.2)	14.0 (6.3)	S582R-PS	R582R-PS

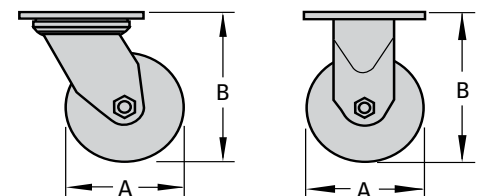

# SERIES 6 HEAVY DUTY (HOT FORGED)

Capacities to 1600 lbs.

## Standard Features

- **Top Plate/Yoke Base** - SAE-1045 drop forged steel
- **Swivel Assembly** - Double ball bearing design. Heat treated machined raceways

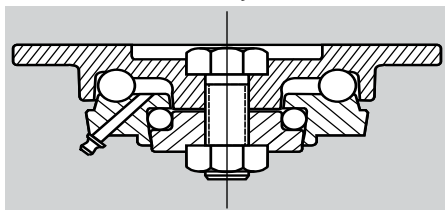

- **King Pin** - 3/4" heat treated bolt and nut
- **Legs** - 1/4" formed for added strength
- **Finish** - Corrosion resistant zinc

## Optional Features

- **Wheel Brake** - (Suffix -WB) cam style



S682R-PA



R662R-PH

- **4-Position Swivel Lock** (Suffix -SL)



## Standard Top Plate

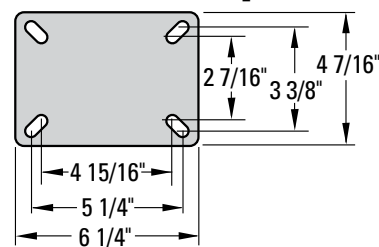

Wheel Specifications						Caster Specifications						Part Number	
Dia. "A" Inches (mm)	Tread Inches (mm)	Wheel Composition	Ref. to Page	Bearing Type	Axle Dia. Inches (mm)	Load Capacity lbs. (KGS)	Overall Height "B" Inches (mm)	Swivel Radius Inches (mm)	Attach. Bolt Inches (mm)	Approx. Shipping Wt.		Swivel Caster	Rigid Caster
										Swivel lbs. (KGS)	Rigid lbs. (KGS)		
4 (102)	2 (50)	Grey Iron (Heavy Duty)	85	Roller	1/2 (13)	1100 (495)	5 5/8 (143)	3 7/16 (87)	3/8 (10)	10.5 (4.7)	6.8 (3.0)	S642R-GI	R642R-GI
		Phenolic	82	Roller		800 (360)				8.5 (3.8)	4.8 (2.0)	S642R-PH	R642R-PH
		Mold-on Rubber (Cast Iron Core)	74	Roller		350 (157)				8.5 (3.8)	4.8 (2.0)	S642R-MR	R642R-MR
		Polyurethane (Cast Iron Core)	78	Roller		700 (315)				8.5 (3.8)	4.8 (2.0)	S642R-PI	R642R-PI
		Polyurethane (Alum. Core)	75	Roller		700 (315)				8.0 (3.6)	4.3 (1.9)	S642R-PA	R642R-PA
		Solid Urethane	77	Roller		700 (315)				8.0 (3.6)	4.3 (1.9)	S642R-KT	R642R-KT
		Severe Duty Polyurethane	79	Roller		800 (360)				10.5 (4.7)	6.8 (3.0)	S642R-PS	R642R-PS
		1 1/2 (38)	Forged Steel	88		Roller				1400 (630)	10.5 (4.7)	6.8 (3.0)	S641R-FS

Wheel Specifications						Caster Specifications						Part Number		
Dia. "A" Inches (mm)	Tread Inches (mm)	Wheel Composition	Ref. to Page	Bearing Type	Axle Dia. Inches (mm)	Load Capacity lbs. (KGS)	Overall Height "B" Inches (mm)	Swivel Radius Inches (mm)	Attach. Bolt Inches (mm)	Approx. Shipping Wt.		Swivel Caster	Rigid Caster	
										Swivel lbs. (KGS)	Rigid lbs. (KGS)			
5 (127)	2 (50)	Grey Iron (Heavy Duty)	85	Roller	1/2 (13)	1000 (450)	6 1/2 (165)	4 5/16 (109)	3/8 (10)	11.0 (4.9)	9.0 (4.0)	S652R-GI	R652R-GI	
		Phenolic	82	Roller		1000 (450)				9.0 (4.0)	7.0 (3.1)	S652R-PH	R652R-PH	
		Mold-on Rubber (Cast Iron Core)	74	Roller		350 (158)				10.0 (4.5)	8.0 (3.6)	S652R-MR	R652R-MR	
		Polyurethane (Cast Iron Core)	78	Roller		1000 (450)				9.5 (4.3)	7.5 (3.4)	S652R-PI	R652R-PI	
		Polyurethane (Alum. Core)	75	Roller		1000 (450)				9.5 (4.3)	7.5 (3.4)	S652R-PA	R652R-PA	
		Solid Urethane	77	Roller		1000 (450)				9.0 (4.0)	7.0 (3.1)	S652R-KT	R652R-KT	
		Severe Duty Polyurethane	79	Roller		1000 (450)				11.0 (4.9)	9.0 (4.0)	S652R-PS	R652R-PS	
		Forged Steel	88	Roller		1500 (675)				11.0 (4.9)	9.0 (4.0)	S652R-FS	R652R-FS	
6 (152)	2 (50)	Grey Iron (Heavy Duty)	85	Roller	1/2 (13)	1200 (540)	7 1/2 (191)	5 1/4 (133)	3/8 (10)	12.0 (5.4)	10.0 (4.5)	S662R-GI	R662R-GI	
		Phenolic	82	Roller		1200 (540)				10.0 (4.5)	8.0 (3.6)	S662R-PH	R662R-PH	
		Mold-on Rubber (Cast Iron Core)	74	Roller		500 (225)				12.0 (5.4)	10.0 (4.5)	S662R-MR	R662R-MR	
		Polyurethane (Cast Iron Core)	78	Roller		1200 (540)				13.0 (5.9)	11.0 (4.9)	S662R-PI	R662R-PI	
		Polyurethane (Alum. Core)	75	Roller		1200 (540)				12.0 (5.4)	10.0 (4.5)	S662R-PA	R662R-PA	
		Solid Urethane	77	Roller		1200 (540)				10.0 (4.5)	8.0 (3.6)	S662R-KT	R662R-KT	
		Severe Duty Polyurethane	79	Roller		1200 (540)				12.0 (5.4)	10.0 (4.5)	S662R-PS	R662R-PS	
		Forged Steel	88	Roller		1200 (540)				12.0 (5.4)	10.0 (4.5)	S662R-FS	R662R-FS	
	2 1/2 (60)	Cast Iron	86	Roller	1/2 (13)	1600 (720)	7 1/2 (191)	5 1/4 (133)	3/8 (10)	15.0 (6.8)	13.0 (5.9)	S6625R-SS	R6625R-SS	
		Phenolic	82	Roller		1600 (720)				13.0 (5.9)	11.0 (4.9)	S6625R-PH	R6625R-PH	
		Mold-on Rubber (Cast Iron Core)	74	Roller		600 (270)				14.0 (6.3)	12.0 (5.4)	S6625R-MR	R6625R-MR	
		Polyurethane (Cast Iron Core)	78	Roller		1500 (675)				16.0 (7.2)	14.0 (6.3)	S6625R-PI	R6625R-PI	
	8 (203)	2 (50)	Grey Iron (Heavy Duty)	85	Roller	1/2 (13)	1500 (675)	10 1/8 (257)	6 1/4 (159)	3/8 (10)	15.0 (6.8)	13.0 (5.9)	S682R-GI	R682R-GI
			Phenolic	82	Roller		1400 (630)				12.0 (5.4)	10.0 (4.5)	S682R-PH	R682R-PH
			Mold-on Rubber (Cast Iron Core)	74	Roller		500 (225)				14.0 (6.3)	12.0 (5.4)	S682R-MR	R682R-MR
			Polyurethane (Cast Iron Core)	78	Roller		1500 (675)				14.0 (6.3)	12.0 (5.4)	S682R-PI	R682R-PI
Polyurethane (Alum. Core)			75	Roller	1500 (675)		13.0 (5.9)				11.0 (4.9)	S682R-PA	R682R-PA	
Solid Urethane			77	Roller	1500 (675)		12.0 (5.4)				10.0 (4.5)	S682R-KT	R682R-KT	
2 1/2 (60)		Severe Duty Polyurethane	79	Roller	1/2 (13)	1500 (675)	10 1/8 (257)	6 1/4 (159)	3/8 (10)	15.0 (6.8)	13.0 (5.9)	S682R-PS	R682R-PS	
		Cast Iron	86	Roller		1600 (720)				17.0 (7.7)	15.0 (6.8)	S6825R-SS	R6825R-SS	
		Phenolic	82	Roller		1600 (720)				14.0 (6.3)	12.0 (5.4)	S6825R-PH	R6825R-PH	
		Mold-on Rubber (Cast Iron Core)	74	Roller		800 (360)				16.0 (7.2)	14.0 (6.3)	S6825R-MR	R6825R-MR	
		Polyurethane (Cast Iron Core)	78	Roller		1600 (720)				17.0 (7.7)	15.0 (6.8)	S6825R-PI	R6825R-PI	
10 (254)	2 1/2 (60)	Cast Iron	86	Roller	1/2 (13)	1600 (720)	11 1/2 (292)	7 1/4 (184)	3/8 (10)	23.0 (10.4)	21.0 (9.5)	S61025R-SS	R61025R-SS	
		Phenolic	82	Roller		1600 (720)				16.0 (7.2)	14.0 (6.3)	S61025R-PH	R61025R-PH	
		Mold-on Rubber (Cast Iron Core)	74	Roller		800 (360)				18.0 (8.1)	16.0 (7.2)	S61025R-MR	R61025R-MR	
		Polyurethane (Cast Iron Core)	78	Roller		1600 (720)				20.0 (9.0)	18.0 (8.1)	S61025R-PI	R61025R-PI	

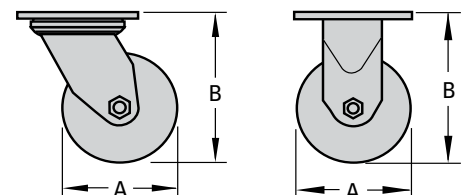



# SERIES 7 HEAVY DUTY

Capacities to 2000 lbs.

## Standard Features

- **Top Plate** - 5/16" drop forged steel
- **Swivel Bearing Raceways** - Heat treated machined races, double row ball bearing construction
- **Legs** - 3/8" thick formed, welded inside and out

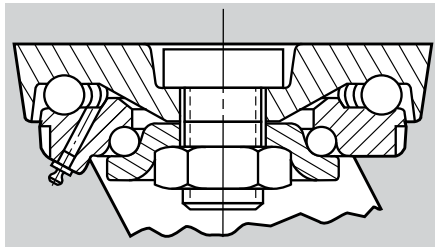

- **King Pin** - 3/4" heat treated bolt and nut
- **Axle** - 3/4" hollow axle with grease zerk
- **Finish** - Corrosion resistant zinc



S783R-SS

## Optional Features

- **Thumb Screw Wheel Brake** - (Suffix **-WB**)
- **Delrin Bearing** - (Change **R** to **D**)  
Example: S783**D**-PH
- **Sealed Wheel** - (Suffix **-SW**)
- **Swivel Lock** - (Suffix **-SL**)

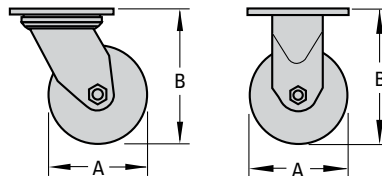

R763R-MR



Thumb Screw Wheel Brake

## Standard Top Plate

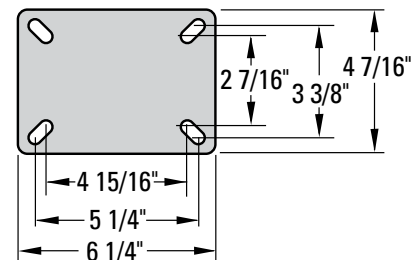

Wheel Specifications						Caster Specifications						Part Number	
Dia. "A" Inches (mm)	Tread Inches (mm)	Wheel Composition	Ref. to Page	Bearing Type	Axle Dia. Inches (mm)	Load Capacity lbs. (KGS)	Overall Height "B" Inches (mm)	Swivel Radius Inches (mm)	Attach. Bolt Inches (mm)	Approx. Shipping Wt.		Swivel Caster	Rigid Caster
										Swivel lbs. (KGS)	Rigid lbs. (KGS)		
6 (152)	3 (76)	Cast Iron	86	Roller	3/4 (20)	2000 (900)	7 1/2 (190)	6 (152)	1/2 (13)	23.0 (10.3)	10.5 (4.7)	S763R-SS	R763R-SS
		Phenolic	82	Roller		2000 (900)				15.0 (6.8)	6.75 (3.0)	S763R-PH	R763R-PH
		Mold-on Rubber (Cast Iron Core)	74	Roller		700 (315)				20.0 (9.0)	9.0 (4.0)	S763R-MR	R763R-MR
		Polyurethane (Cast Iron Core)	78	Roller		2000 (900)				21.0 (9.5)	9.5 (4.3)	S763R-PI	R763R-PI
8 (203)	3 (76)	Cast Iron	86	Roller	3/4 (20)	2000 (900)	10 1/8 (257)	7 (178)	1/2 (13)	24.0 (10.5)	11.0 (5.0)	S783R-SS	R783R-SS
		Phenolic	82	Roller		2000 (900)				19.0 (8.6)	8.5 (3.8)	S783R-PH	R783R-PH
		Mold-on Rubber (Cast Iron Core)	74	Roller		840 (378)				21.0 (9.5)	9.5 (4.3)	S783R-MR	R783R-MR
		Polyurethane (Cast Iron Core)	78	Roller		2000 (900)				23.0 (10.4)	10.5 (4.7)	S783R-PI	R783R-PI
10 (254)	3 (76)	Cast Iron	86	Roller	3/4 (20)	2000 (900)	11 1/2 (292)	8 1/2 (216)	1/2 (13)	27.0 (12.2)	12.0 (5.4)	S7103R-SS	R7103R-SS
		Phenolic	82	Roller		2000 (900)				21.0 (9.5)	9.5 (4.3)	S7103R-PH	R7103R-PH
		Mold-on Rubber (Cast Iron Core)	74	Roller		1000 (450)				23.0 (10.4)	10.5 (4.7)	S7103R-MR	R7103R-MR
		Polyurethane (Cast Iron Core)	78	Roller		2000 (900)				28.0 (12.6)	12.5 (5.6)	S7103R-PI	R7103R-PI
12 (305)	3 (76)	Cast Iron	86	Roller	3/4 (20)	2000 (900)	13 1/2 (343)	9 (228)	1/2 (13)	32.0 (14.4)	14.5 (6.5)	S7123R-SS	R7123R-SS
		Phenolic	82	Roller		2000 (900)				24.0 (10.8)	11.0 (5.0)	S7123R-PH	R7123R-PH
		Mold-on Rubber (Cast Iron Core)	74	Roller		1140 (513)				30.0 (13.5)	13.5 (6.1)	S7123R-MR	R7123R-MR
		Polyurethane (Cast Iron Core)	78	Roller		2000 (900)				35.0 (15.8)	16.0 (7.2)	S7123R-PI	R7123R-PI

# SERIES 8 HEAVY DUTY

Capacities to 3500 lbs.

## Standard Features

- **Top Plate** - Drop-forged from SAE-1045 steel for extra-heavy duty construction
- **Yoke Base** - Drop-forged SAE-1045 steel, full 1/2" thick at maximum stress point. Notched for optional 4-position lock
- **Main Load Bearing** - Fully hardened 1/2" diameter balls in 4" diameter hardened raceways
- **Thrust Load Bearings** - Hardened, 3/8" ball bearings in a recessed race cone take away thrust loads from kingbolt

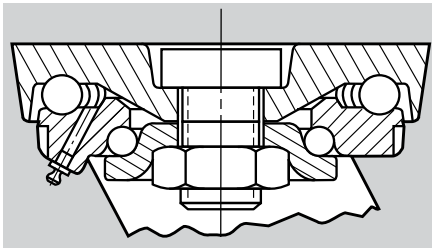

- **King Pin** - 1" diameter bolt and nut
- **Formed Swivel Legs** - Forged from 3/8" steel with coined offset for added strength, then welded on both sides to the yoke base
- **Wheel Bearings** - Roller bearings are standard for all wheel sizes
- **Axle** - 3/4" hollow axle with grease zerk
- **Pressure Lubrication** - Fittings are standard at swivel and recessed head of hollow axles
- **Finish** - Corrosion resistant zinc

## Standard Top Plate

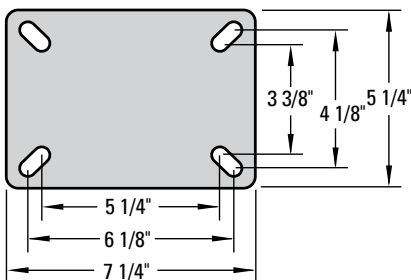

SERIES 8 CONTINUES ON THE NEXT PAGE



S8103T-PI



R863R-SS

## Optional Features

- **Sealed Wheel** - (Suffix -SW)
- **Thumb Screw Wheel Brake** - (Suffix -WB)



- **Four-Position Swivel Lock** - (Suffix -SL) Field Installable



Swivel lock plunger may be ordered separately (Part No. **8SL**)

# SERIES 8 (CONTINUED) HEAVY DUTY

Wheel Specifications						Caster Specifications						Part Number	
Dia. "A" Inches (mm)	Tread Inches (mm)	Wheel Composition	Ref. to Page	Bearing Type	Axle Dia. Inches (mm)	Load Capacity lbs. (KGS)	Overall Height "B" Inches (mm)	Swivel Radius Inches (mm)	Attach. Bolt Inches (mm)	Approx. Shipping Wt.		Swivel Caster	Rigid Caster
										Swivel lbs. (KGS)	Rigid lbs. (KGS)		
6 (152)	3 (76)	Cast Iron	86	Roller	3/4 (19)	2500 (1125)	8 (203)	5 3/8 (136)	1/2 (13)	26.0 (11.7)	20.0 (9.0)	S863R-SS	R863R-SS
		Grey Iron	85	Tapered Roller		2500 (1125)				30.0 (13.5)	24.0 (10.8)	S863T-GI	R863T-GI
		Mold-on Rubber (Cast Iron Core)	74	Roller		700 (315)				20.0 (9.0)	14.0 (6.3)	S863R-MR	R863R-MR
		Mold-on Rubber (Cast Iron Core)	74	Tapered Roller		700 (315)				20.0 (9.0)	14.0 (6.3)	S863T-MR	R863T-MR
		Polyurethane (Cast Iron Core)	78	Roller		2500 (1125)				22.0 (9.9)	16.0 (7.2)	S863R-PI	R863R-PI
		Severe Duty Polyurethane	79	Tapered Roller		2500 (1125)				24.0 (10.8)	18.0 (8.1)	S863T-PS	R863T-PS
		Phenolic	82	Roller		2000 (900)				18.0 (8.1)	12.0 (5.4)	S863R-PH	R863R-PH
8 (203)	3 (76)	Cast Iron	86	Roller	3/4 (19)	2500 (1125)	10 1/2 (267)	6 5/8 (168)	1/2 (13)	28.0 (12)	25.0 (11.3)	S883R-SS	R883R-SS
		Grey Iron	85	Tapered Roller		2500 (1125)				32.0 (14.4)	29.0 (13)	S883T-GI	R883T-GI
		Mold-on Rubber (Cast Iron Core)	74	Roller		840 (378)				22.0 (9.9)	19.0 (8.6)	S883R-MR	R883R-MR
		Mold-on Rubber (Cast Iron Core)	74	Tapered Roller		840 (378)				22.0 (9.9)	19.0 (8.6)	S883T-MR	R883T-MR
		Polyurethane (Cast Iron Core)	78	Roller		2500 (1125)				24.0 (10.8)	21.0 (9.5)	S883R-PI	R883R-PI
		Severe Duty Polyurethane	79	Tapered Roller		2500 (1125)				26.0 (11.7)	23.0 (10.4)	S883T-PS	R883T-PS
		Phenolic	82	Roller		2500 (1125)				20.0 (9.0)	17.0 (7.7)	S883R-PH	R883R-PH
10 (254)	3 (76)	Cast Iron	86	Roller	3/4 (19)	3000 (1350)	12 1/2 (317)	7 5/8 (194)	1/2 (13)	35.0 (15.8)	29.0 (13.1)	S8103R-SS	R8103R-SS
		Grey Iron	85	Tapered Roller		3000 (1350)				38.0 (17.1)	31.0 (14)	S8103T-GI	R8103T-GI
		Mold-on Rubber (Cast Iron Core)	74	Roller		1000 (450)				31.0 (14)	25.0 (11.3)	S8103R-MR	R8103R-MR
		Mold-on Rubber (Cast Iron Core)	74	Tapered Roller		1000 (450)				32.0 (14.4)	26.0 (11.7)	S8103T-MR	R8103T-MR
		Polyurethane (Cast Iron Core)	78	Roller		3000 (1350)				36.0 (16.2)	30.0 (14)	S8103R-PI	R8103R-PI
		Severe Duty Polyurethane	79	Tapered Roller		3000 (1350)				37.0 (16.7)	31.0 (14)	S8103T-PS	R8103T-PS
		Phenolic	82	Roller		2900 (1305)				28.0 (12.6)	22.0 (9.9)	S8103R-PH	R8103R-PH
12 (305)	3 (76)	Cast Iron	86	Roller	3/4 (19)	3000 (1350)	15 1/2 (394)	8 5/8 (219)	1/2 (13)	41.0 (18.5)	35.0 (15.8)	S8123R-SS	R8123R-SS
		Mold-on Rubber (Cast Iron Core)	74	Roller		1500 (675)				37.0 (16.7)	31.0 (14)	S8123R-MR	R8123R-MR
		Mold-on Rubber (Cast Iron Core)	74	Tapered Roller		1500 (675)				38.0 (17.1)	32.0 (14.4)	S8123T-MR	R8123T-MR
		Polyurethane (Cast Iron Core)	78	Roller		3500 (1575)				41.0 (18.5)	35.0 (15.8)	S8123R-PI	R8123R-PI
		Severe Duty Polyurethane	79	Tapered Roller		3500 (1575)				41.0 (18.5)	35.0 (15.8)	S8123T-PS	R8123T-PS
		Phenolic	82	Roller		3500 (1575)				32.0 (14.4)	28.0 (12.6)	S8123R-PH	R8123R-PH

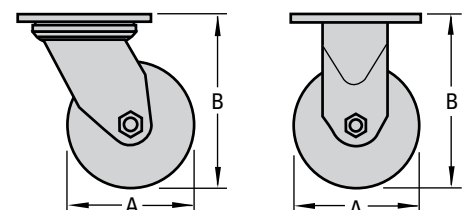

# SERIES 9 TRAILER DUTY

Capacities to 3500 lbs.

## Standard Features

- **Top Plate** - 1" thick SAE-1045 steel plate
- **Swivel Assembly** - 7" diameter ball bearing load raceway, sealed tapered roller thrust bearing

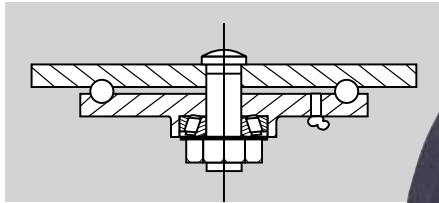

- **King Pin** - 1 1/4" diameter heat treated bolt and nut
- **Legs** - 3/8" formed steel
- **Finish** - Zinc plated

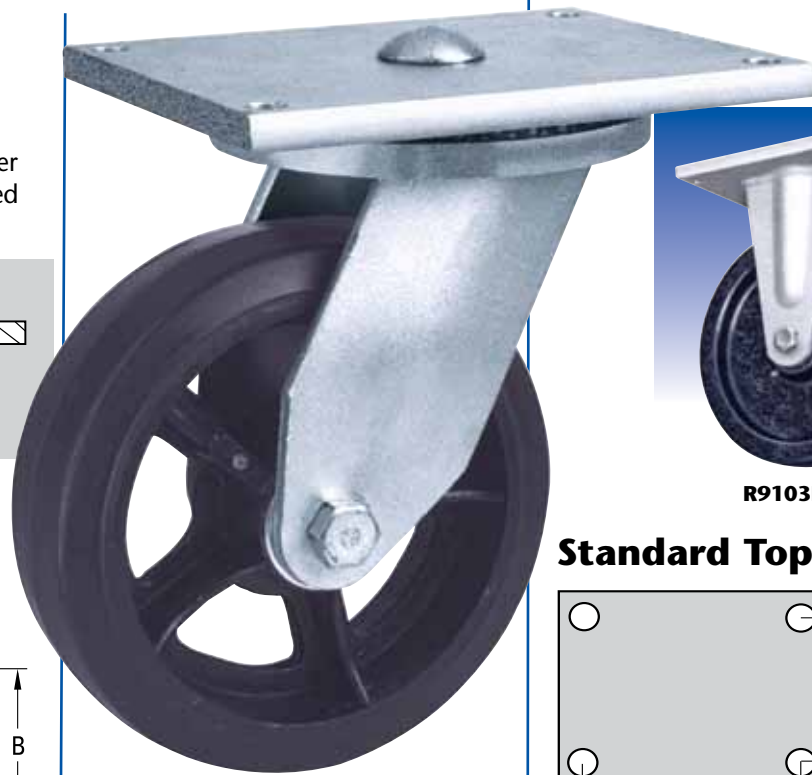
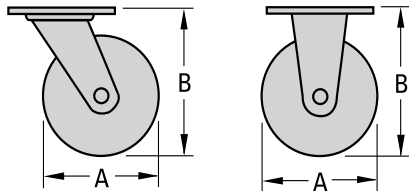

S9103T-MR



R9103R-PH

## Standard Top Plate

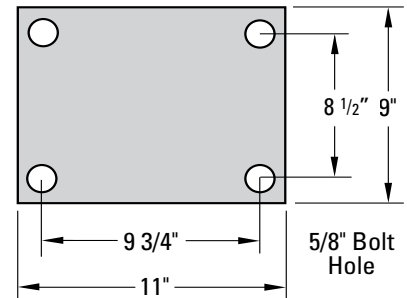

Wheel Specifications						Caster Specifications						Part Number	
Dia. "A" Inches (mm)	Tread Inches (mm)	Wheel Composition	Ref. to Page	Bearing Type	Axle Dia. Inches (mm)	Load Capacity lbs. (KGS)	Overall Height "B" Inches (mm)	Swivel Radius Inches (mm)	Attach. Bolt Inches (mm)	Approx. Shipping Wt.		Swivel Caster	Rigid Caster
										Swivel lbs. (KGS)	Rigid lbs. (KGS)		
8 (203)	3 (76)	Mold-on Rubber (Cast Iron Core)	74	Tapered Roller	3/4 (19)	840 (378)	11 (279)	7 (178)	5/8 (16)	48 (22)	34 (15)	S983T-MR	R983T-MR
		Polyurethane (Cast Iron Core)	78	Tapered Roller		2520 (1134)				52 (23)	38 (17)	S983T-PI	R983T-PI
		Phenolic Resin	82	Roller		2500 (1125)				43 (19)	29 (13)	S983R-PH	R983R-PH
		Cast Iron (Heavy Duty)	86	Roller		2500 (315)				49 (22)	35 (16)	S983R-SS	R983R-SS
10 (254)	3 (76)	Mold-on Rubber (Cast Iron Core)	74	Tapered Roller	3/4 (19)	1000 (450)	12 7/8 (327)	8 (203)	5/8 (16)	50 (22)	36 (16)	S9103T-MR	R9103T-MR
		Polyurethane (Cast Iron Core)	78	Tapered Roller		3000 (1350)				56 (25)	42 (19)	S9103T-PI	R9103T-PI
		Phenolic Resin	82	Roller		3000 (1350)				46 (21)	32 (14)	S9103R-PH	R9103R-PH
		Cast Iron (Heavy Duty)	86	Roller		2500 (1125)				53 (24)	39 (17)	S9103R-SS	R9103R-SS
12 (305)	3 (76)	Mold-on Rubber (Cast Iron Core)	74	Tapered Roller	3/4 (19)	1140 (513)	14 7/8 (378)	9 1/2 (241)	5/8 (16)	56 (25)	42 (19)	S9123T-MR	R9123T-MR
		Polyurethane (Cast Iron Core)	78	Tapered Roller		3400 (1530)				65 (29)	51 (23)	S9123T-PI	R9123T-PI
		Phenolic Resin	82	Roller		3500 (1575)				50 (22)	36 (16)	S9123R-PH	R9123R-PH
		Cast Iron (Heavy Duty)	86	Roller		2500 (1125)				59 (26)	45 (20)	S9123R-SS	R9123R-SS

**APPLICATIONS:**  
Heavy duty power drawn trailers and drag line operations. Extreme swivel offset allows for high maneuverability.



# SERIES 10 HEAVY DUTY

Capacities to 3400 lbs.

## Standard Features

- **Top Plate/Yoke Base** - Drop forged from SAE-1050 steel
- **King Pin** - 1" integrally forged, turned to 3/4" for a slotted adjusting nut
- **Side Forks** - 3/8" thick heavily embossed
- **Swivel Assembly** - Precision machined, flame hardened raceway for 3/8" dia. hardened steel ball bearings. Tapered thrust bearing
- **Wheel Bearings** - 3/4" I.D. tapered roller bearings in all wheels
- **Axle** - Specially ground 3/4" diameter, locked in position with indexing lance in side fork

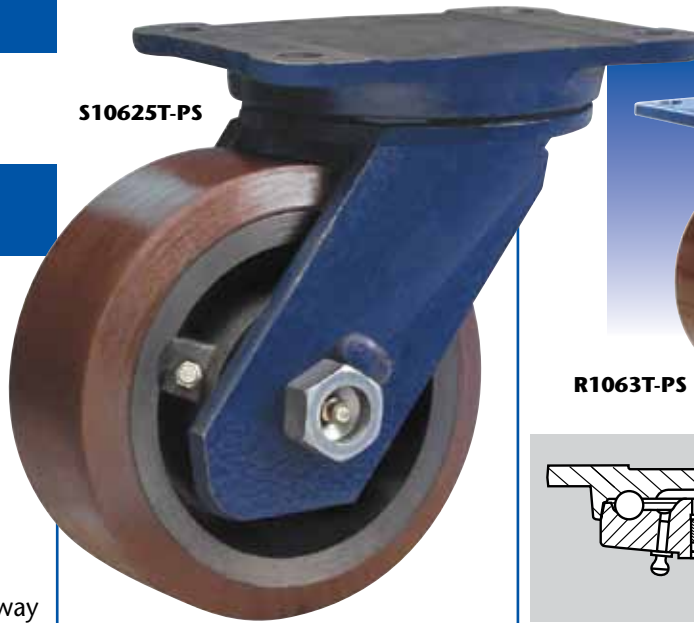

S10625T-PS



R1063T-PS

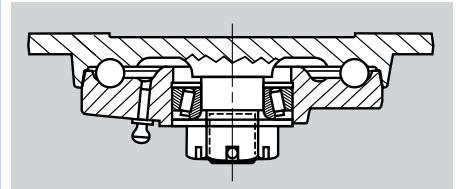

## Optional Features

- **Heavy Duty 1, 2, or 4 Position Swivel Lock** (Suffix -1SL, -2SL or -4SL)
- **Secure Face Contact Brake** (Suffix -FCB)

## Standard Top Plate

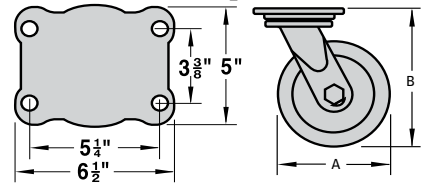

Wheel Specifications					Caster Specifications						Part Number	
Dia. "A" Inches (mm)	Tread Inches (mm)	Wheel Composition	Bearing Type	Axle Dia. Inches (mm)	Load Capacity lbs. (KGS)	Overall Height "B" Inches (mm)	Swivel Radius Inches (mm)	Attach. Bolt Inches (mm)	Approx. Shipping Wt.		Swivel Caster	Rigid Caster
									Swivel lbs. (KGS)	Rigid lbs. (KGS)		
6 (152)	2 1/2 (64)	Grey Iron (Heavy Duty)	Tapered Roller	3/4 (19)	3000 (1350)	7 1/2 (191)	5 5/8 (143)	1/2 (13)	21.2 (9.5)	19.0 (8.6)	S10625T-GI	R10625T-GI
		Mold-on Rubber (Cast Iron Core)	Tapered Roller		540 (243)				17.4 (7.8)	15.1 (6.8)	S10625T-MR	R10625T-MR
		Severe Duty Polyurethane	Tapered Roller		1600 (720)				19.5 (8.8)	17.2 (7.7)	S10625T-PS	R10625T-PS
		Phenolic	Tapered Roller		1600 (720)				13.9 (6.3)	11.6 (5.2)	S10625T-PH	R10625T-PH
	3 (76)	Grey Iron (Heavy Duty)	Tapered Roller	3/4 (19)	3100 (1395)	9 1/2 (241)	5 1/2 (140)	1/2 (13)	25.4 (14.4)	23.0 (10.4)	S1063T-GI	R1063T-GI
		Mold-on Rubber (Cast Iron Core)	Tapered Roller		680 (306)				21.6 (9.7)	19.2 (8.6)	S1063T-MR	R1063T-MR
		Severe Duty Polyurethane	Tapered Roller		2000 (900)				23.7 (10.7)	21.3 (9.6)	S1063T-PS	R1063T-PS
		Phenolic	Tapered Roller		2000 (900)				15.6 (7.0)	13.0 (5.9)	S1063T-PH	R1063T-PH
8 (203)	3 (76)	Grey Iron (Heavy Duty)	Tapered Roller	3/4 (19)	3200 (1440)	10 1/2 (276)	6 1/2 (165)	1/2 (13)	29.3 (13.2)	26.9 (12.1)	S1083T-GI	R1083T-GI
		Mold-on Rubber (Cast Iron Core)	Tapered Roller		840 (378)				29.1 (13.1)	26.7 (12)	S1083T-MR	R1083T-MR
		Severe Duty Polyurethane	Tapered Roller		2500 (1125)				25.4 (11.4)	22.9 (10.3)	S1083T-PS	R1083T-PS
		Phenolic	Tapered Roller		2500 (1125)				17.5 (7.9)	15.0 (6.8)	S1083T-PH	R1083T-PH
10 (254)	3 (76)	Grey Iron (Heavy Duty)	Tapered Roller	3/4 (19)	3400 (1530)	12 1/2 (318)	7 1/2 (191)	1/2 (13)	34.6 (15.6)	32.4 (14.6)	S10103T-GI	R10103T-GI
		Mold-on Rubber (Cast Iron Core)	Tapered Roller		1000 (450)				34.7 (15.6)	32.5 (15.7)	S10103T-MR	R10103T-MR
		Severe Duty Polyurethane	Tapered Roller		2600 (1170)				37.2 (16.7)	34.8 (15.7)	S10103T-PS	R10103T-PS
		Phenolic	Tapered Roller		2900 (1305)				21.1 (9.5)	18.9 (8.5)	S10103T-PH	R10103T-PH
12 (305)	3 (76)	Mold-on Rubber (Cast Iron Core)	Tapered Roller	3/4 (19)	1140 (513)	14 1/2 (368)	9 1/2 (241)	1/2 (13)	36.9 (16.6)	34.9 (15.7)	S10123T-MR	R10123T-MR
		Severe Duty Polyurethane	Tapered Roller		3400 (1530)				39.7 (17.9)	37.8 (17.1)	S10123T-PS	R10123T-PS



# SERIES 11 HEAVY DUTY

Capacities to 4200 lbs.

## Standard Features

- **Top Plate/Yoke Base** - Drop forged from SAE-1050 steel
- **Swivel Assembly** - Precision machined, flame hardened race-way for 1/2" diameter hardened steel ball bearings. Tapered thrust bearing
- **King Pin** - 1 1/4" integrally forged, turned to 1" diameter for a slotted adjusting nut
- **Wheel Bearings** - 3/4" I.D. tapered roller bearings in all wheels
- **Side Forks** - 3/8" thick x 4" extra wide for maximum strength
- **Axle** - Specially ground 3/4" diameter, locked in position with indexing lance in side fork

S1183T-GI

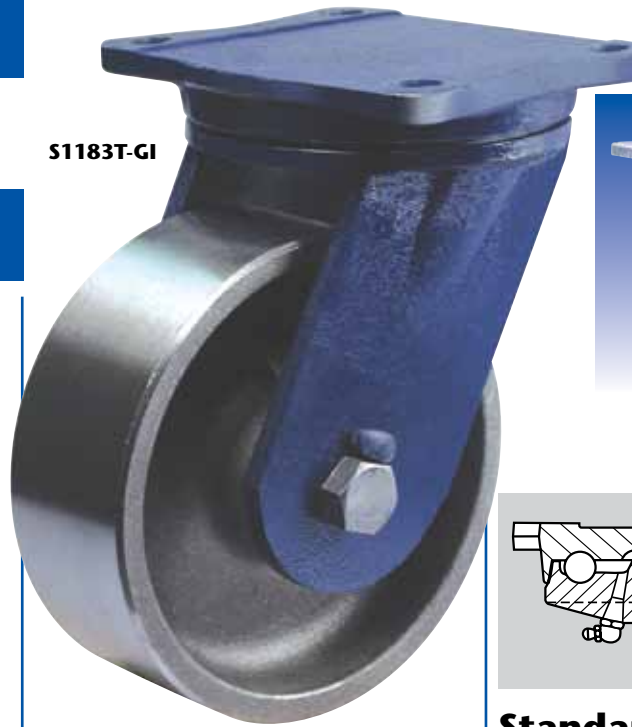

R1163T-MR

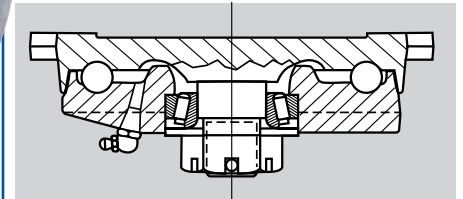

## Standard Top Plate

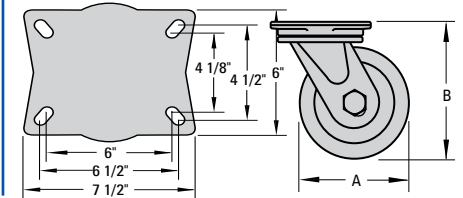

## Optional Features

- **Heavy Duty 1, 2, or 4 Position Swivel Lock** (Suffix -1SL, -2SL or -4SL)
- **Secure Face Contact Brake** (Suffix -FCB)

Wheel Specifications						Caster Specifications						Part Number	
Dia. "A" Inches (mm)	Tread Inches (mm)	Wheel Composition	Ref. to Page	Bearing Type	Axle Dia. Inches (mm)	Load Capacity lbs. (KGS)	Overall Height "B" Inches (mm)	Swivel Radius Inches (mm)	Attach. Bolt Inches (mm)	Approx. Shipping Wt.		Swivel Caster	Rigid Caster
										Swivel lbs. (KGS)	Rigid lbs. (KGS)		
6 (152)	3 (76)	Grey Iron (Heavy Duty)	85	Tapered Roller	3/4 (19)	3100 (1395)	9 1/2 (241)	5 1/2 (140)	1/2 (13)	35.0 (15.8)	27.0 (12.1)	S1163T-GI	R1163T-GI
		Mold-on Rubber (Cast Iron Core)	74	Tapered Roller		680 (306)				31.2 (14.0)	23.2 (10.4)	S1163T-MR	R1163T-MR
		Severe Duty Polyurethane	79	Tapered Roller		2000 (900)				33.7 (15.2)	25.3 (11.3)	S1163T-PS	R1163T-PS
		Phenolic	82	Tapered Roller		2000 (900)				25.2 (11.3)	17.0 (7.6)	S1163T-PH	R1163T-PH
8 (203)	3 (76)	Grey Iron (Heavy Duty)	85	Tapered Roller	3/4 (19)	3400 (1350)	10 1/2 (267)	6 1/2 (165)	1/2 (13)	39.6 (17.8)	31.4 (14.1)	S1183T-GI	R1183T-GI
		Mold-on Rubber (Cast Iron Core)	74	Tapered Roller		840 (378)				34.0 (15.3)	25.8 (11.6)	S1183T-MR	R1183T-MR
		Severe Duty Polyurethane	79	Tapered Roller		2500 (1125)				35.7 (16.0)	27.4 (12.3)	S1183T-PS	R1183T-PS
		Phenolic	82	Tapered Roller		2500 (1125)				28.8 (13.0)	19.5 (8.7)	S1183T-PH	R1183T-PH
10 (254)	3 (76)	Grey Iron (Heavy Duty)	85	Tapered Roller	3/4 (19)	3600 (1620)	12 1/2 (317)	7 1/2 (191)	1/2 (13)	45.1 (20.2)	37.1 (16.6)	S11103T-GI	R11103T-GI
		Mold-on Rubber (Cast Iron Core)	74	Tapered Roller		450 (450)				45.2 (20.3)	37.2 (16.7)	S11103T-MR	R11103T-MR
		Severe Duty Polyurethane	79	Tapered Roller		2600 (1170)				47.7 (21.5)	39.5 (17.7)	S11103T-PS	R11103T-PS
		Phenolic	82	Tapered Roller		2900 (1305)				31.6 (14.2)	23.6 (10.6)	S11103T-PH	R11103T-PH
	4 (102)	Grey Iron (Heavy Duty)	85	Tapered Roller	3/4 (19)	4200 (1890)	12 1/2 (317)	7 1/2 (191)	1/2 (13)	48.5 (21.8)	39.7 (17.8)	S11104T-GI	R11104T-GI
		Mold-on Rubber (Cast Iron Core)	74	Tapered Roller		1400 (630)				50.9 (22.9)	42.2 (18.9)	S11104T-MR	R11104T-MR
		Severe Duty Polyurethane	79	Tapered Roller		4200 (1890)				34.8 (15.6)	26.2 (11.7)	S11104T-PS	R11104T-PS
12 (305)	3 (76)	Mold-on Rubber (Cast Iron Core)	74	Tapered Roller	3/4 (19)	1140 (513)	14 1/2 (368)	9 1/2 (241)	1/2 (13)	48.3 (21.7)	39.9 (17.9)	S11123T-MR	R11123T-MR
		Severe Duty Polyurethane	79	Tapered Roller		3500 (1575)				48.8 (21.9)	40.4 (18.1)	S11123T-PS	R11123T-PS