

SERIES 03/04 LIGHT MEDIUM DUTY PLATE

Capacities to 300 lbs.

Standard Features

- **Swivel Casters** - Heavy gauge steel top plate is attached to a full drawn steel horn with integral, hardened raceways

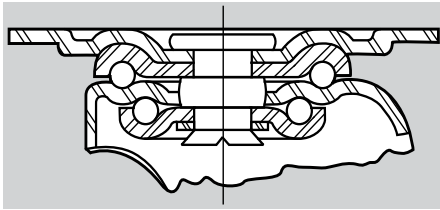

- **Load Bearings** - Two full, independent rows of hardened, polished ball bearings roll freely in large diameter, lubricated raceways
- **King Pin** - Shank, hardened king pin holds raceways precisely in alignment
- **Wheel Bearings** - Self lubricating, plain, ball, and roller bearings are available
- **Finish** - Corrosion resistant zinc



03-PPB-25

Optional Features

- **Tread Contact Brake** - (Suffix-WB)
Not available on 3" caster, rigid caster, or roller bearing wheels.



- **Grease Seals** - (Suffix-GS)
- **Total Lock Wheel Brake** - (Suffix-TLB)
Available for 3 1/2", 4" and 5" dia.

APPLICATIONS:

All purpose series found in virtually all institutional as well as light industrial environments.

The range of wheel materials available make this a popular series with schools and hospitals.



04-SPB-5

Standard Top Plates

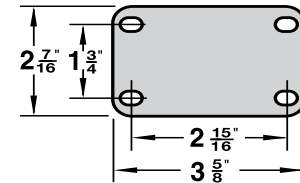

Swivel Caster

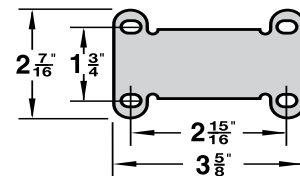

Rigid Caster

Wheel Specifications				Caster Specifications						Part Number			
Dia. "A" Inches (mm)	Tread Inches (mm)	Wheel Composition	Bearing Type	Axle Dia. Inches (mm)	Load Capacity lbs. (KGS)	Overall Height "B" Inches (mm)	Swivel Radius Inches (mm)	Attach. Bolt Inches (mm)	Approx. Shipping Wt.		Swivel Caster	Rigid Caster	
									Swivel lbs. (KGS)	Rigid lbs. (KGS)			
2 1/2 (60)	1 1/8 (29)	Sintered Iron	Plain	5/16 (8)	200 (90)	3 5/16 (84)	2 3/8 (60)	5/16 (8)	1.8 (.81)	1.1 (.50)	03-SIP-25	04-SIP-25	
		Soft Rubber	Self Lube		100 (45)				1.2 (.54)	.90 (.40)	03-SRP-25	04-SRP-25	
		Hard Rubber	Self Lube		200 (90)				1.2 (.54)	.90 (.40)	03-HRP-25	04-HRP-25	
		Polyurethane (Polyolefin Core)	Ball		200 (90)				1.3 (.59)	1.0 (.45)	03-PPB-25	04-PPB-25	
		Polyolefin (Blk)	Plain		200 (90)				1.1 (.50)	.80 (.36)	03-PBP-25	04-PBP-25	
		Polyolefin (Wt)	Plain		200 (90)				1.1 (.50)	.80 (.36)	03-PWP-25	04-PWP-25	
3 (76)	1 5/16 (33)	Sintered Iron	Plain	3/8 (8)	300 (135)	3 13/16 (97)	2 3/4 (70)	5/16 (8)	2.0 (.90)	1.8 (.81)	03-SIP-3	04-SIP-3	
		Cast Iron	Roller		300 (135)				2.4 (1.08)	2.2 (1.0)	03-SSR-3	04-SSR-3	
		Soft Rubber	Self Lube		175 (79)				1.4 (.63)	1.2 (.54)	03-SRP-3	04-SRP-3	
		Soft Rubber	Roller		175 (79)				1.4 (.63)	1.2 (.54)	03-SRR-3	04-SRR-3	
		Hard Rubber	Self Lube		270 (121)				1.4 (.63)	1.2 (.54)	03-HRP-3	04-HRP-3	
		Hard Rubber	Roller		270 (121)				1.4 (.63)	1.2 (.54)	03-HRR-3	04-HRR-3	
	1 3/8 (35)	Polyurethane (Polyolefin Core)	Ball		250 (112)				1.5 (.68)	1.3 (.59)	03-PPB-3	04-PPB-3	
		1 1/4 (32)	Solid Urethane		Plain				275 (124)	1.5 (.68)	1.3 (.59)	03-KTP-3	04-KTP-3
			Polyolefin (Blk)		Plain				270 (121)	1.1 (.50)	.90 (.40)	03-PBP-3	04-PBP-3
			Polyolefin (Wt)		Plain				270 (121)	1.1 (.50)	.90 (.40)	03-PWP-3	04-PWP-3
			Phenolic		Plain				300 (135)	1.5 (.68)	1.3 (.59)	03-PHP-3	04-PHP-3
			Phenolic		Roller				300 (135)	1.5 (.68)	1.3 (.59)	03-PHR-3	04-PHR-3

Wheel Specifications					Caster Specifications						Part Number		
Dia. "A" Inches (mm)	Tread Inches (mm)	Wheel Composition	Ref. to Page	Bearing Type	Axle Dia. Inches (mm)	Load Capacity lbs. (KGS)	Overall Height "B" Inches (mm)	Swivel Radius Inches (mm)	Attach. Bolt Inches (mm)	Approx. Shipping Wt.		Swivel Caster	Rigid Caster
										Swivel lbs. (KGS)	Rigid lbs. (KGS)		
3 1/2 (89)	1 1/4 (32)	Cast Iron	86	Plain	3/8 (10)	300 (135)	4 3/4 (121)	3 3/16 (81)	5/16 (8)	3.0 (1.35)	2.6 (1.17)	03-SSP-35	04-SSP-35
		Cast Iron	86	Roller		300 (135)				3.0 (1.35)	2.6 (1.17)	03-SSR-35	04-SSR-35
	1 5/16 (33)	Soft Rubber	73	Self Lube		200 (90)				1.9 (.86)	1.5 (.68)	03-SRP-35	04-SRP-35
		Rubber Tire (Steel Disc)	N/A	Ball		200 (90)				2.2 (1.0)	1.8 (.81)	03-RTB-35	04-RTB-35
	1 1/8 (29)	Hard Rubber	84	Self Lube		275 (124)				1.9 (.86)	1.5 (.68)	03-HRP-35	04-HRP-35
	1 5/16 (33)	Hard Rubber	84	Roller		275 (124)				1.9 (.86)	1.5 (.68)	03-HRR-35	04-HRR-35
		Polyurethane (Polyolefin Core)	80	Ball		250 (112)				1.8 (.81)	1.4 (.63)	03-PPB-35	04-PPB-35
		Polyurethane (Polyolefin Core)	72	Delrin		250 (112)				1.8 (.81)	1.4 (.63)	03-PPD-35	04-PPD-35
		Santoprene (Polyolefin Core)	72	Ball		200 (90)				1.8 (.81)	1.4 (.63)	03-SPB-35	04-SPB-35
	1 1/4 (32)	Santoprene (Polyolefin Core)	81	Delrin		200 (90)				1.8 (.81)	1.4 (.63)	03-SPD-35	04-SPD-35
		Polyolefin (Blk)	81	Plain		270 (121)				1.6 (.72)	1.2 (.54)	03-PBP-35	04-PBP-35
		Polyolefin (Wt)	81	Plain		270 (121)				1.6 (.72)	1.2 (.54)	03-PWP-35	04-PWP-35
		Phenolic	82	Plain		300 (135)				2.0 (.90)	1.6 (.72)	03-PHP-35	04-PHP-35
	1 1/4 (32)	Phenolic	82	Roller		300 (135)				2.0 (.90)	1.6 (.72)	03-PHR-35	04-PHR-35
		Cast Iron	86	Plain		300 (135)				3.3 (1.49)	2.9 (1.31)	03-SSP-4	04-SSP-4
	4 (102)	1 1/4 (32)	Cast Iron	86		Roller				300 (135)	3.3 (1.49)	2.9 (1.31)	03-SSR-4
Soft Rubber			73	Self Lube	200 (90)	2.2 (1.0)	1.8 (.81)	03-SRP-4	04-SRP-4				
1 1/8 (29)		Rubber Tire (Steel Disc)	N/A	Ball	200 (90)	2.5 (1.13)	2.1 (.95)	03-RTB-4	04-RTB-4				
		Hard Rubber	84	Self Lube	275 (124)	2.2 (1.0)	1.8 (.81)	03-HRP-4	04-HRP-4				
1 1/4 (32)		Hard Rubber	84	Roller	275 (124)	2.2 (1.0)	1.8 (.81)	03-HRR-4	04-HRR-4				
		Solid Urethane	77	Plain	275 (124)	2.2 (1.0)	1.8 (.81)	03-KTP-4	04-KTP-4				
		Polyurethane (Polyolefin Core)	80	Ball	250 (112)	2.1 (.95)	1.7 (.77)	03-PPB-4	04-PPB-4				
		Polyurethane (Polyolefin Core)	80	Delrin	250 (112)	2.1 (.95)	1.7 (.77)	03-PPD-4	04-PPD-4				
1 3/8 (35)		Santoprene (Polyolefin Core)	72	Ball	200 (90)	2.1 (.95)	1.7 (.77)	03-SPB-4	04-SPB-4				
		Santoprene (Polyolefin Core)	72	Delrin	200 (90)	2.1 (.95)	1.7 (.77)	03-SPD-4	04-SPD-4				
		Polyolefin (Blk)	81	Plain	275 (124)	1.9 (.86)	1.5 (.68)	03-PBP-4	04-PBP-4				
		Polyolefin (Wt)	81	Plain	275 (124)	1.9 (.86)	1.5 (.68)	03-PWP-4	04-PWP-4				
1 1/4 (32)		Phenolic	82	Plain	300 (127)	2.2 (1.0)	1.8 (.81)	03-PHP-4	04-PHP-4				
		Phenolic	82	Roller	300 (127)	2.2 (1.0)	1.8 (.81)	03-PHR-4	04-PHR-4				
		Cast Iron	86	Plain	300 (135)	3.8 (1.7)	3.4 (1.5)	03-SSP-5	04-SSP-5				
		5 (127)	1 1/4 (32)	Cast Iron	86	Roller	300 (135)	3.8 (1.7)	3.4 (1.5)	03-SSR-5	04-SSR-5		
Soft Rubber	72			Self Lube	200 (90)	2.9 (1.3)	2.5 (1.1)	03-SRP-5	04-SRP-5				
1 1/8 (29)	Soft Rubber		72	Ball	200 (90)	2.9 (1.3)	2.5 (1.1)	03-SRB-5	04-SRB-5				
	Rubber Tire (Steel Disc)		N/A	Ball	240 (108)	3.0 (1.35)	2.6 (1.2)	03-RTB-5	04-RTB-5				
1 1/4 (32)	Hard Rubber		84	Self Lube	275 (124)	2.9 (1.3)	2.5 (1.1)	03-HRP-5	04-HRP-5				
	Hard Rubber		84	Roller	275 (124)	2.9 (1.3)	2.5 (1.1)	03-HRR-5	04-HRR-5				
	Solid Urethane		77	Plain	300 (135)	2.9 (1.3)	2.5 (1.1)	03-KTP-5	04-KTP-5				
	Polyurethane (Polyolefin Core)		80	Ball	275 (124)	2.9 (1.3)	2.5 (1.1)	03-PPB-5	04-PPB-5				
1 3/8 (35)	Polyurethane (Polyolefin Core)		80	Delrin	275 (124)	2.9 (1.3)	2.5 (1.1)	03-PPD-5	04-PPD-5				
	Santoprene (Polyolefin Core)		72	Ball	225 (101)	2.9 (1.3)	2.5 (1.1)	03-SPB-5	04-SPB-5				
	Santoprene (Polyolefin Core)		72	Delrin	225 (101)	2.9 (1.3)	2.5 (1.1)	03-SPD-5	04-SPD-5				
	Polyolefin (Blk)		81	Plain	275 (124)	2.5 (1.1)	2.1 (.95)	03-PBP-5	04-PBP-5				
1 1/4 (32)	Polyolefin (Wt)		81	Plain	275 (124)	2.5 (1.1)	2.1 (.95)	03-PWP-5	04-PWP-5				
	Phenolic		82	Plain	300 (135)	2.9 (1.3)	2.5 (1.1)	03-PHP-5	04-PHP-5				
	Phenolic		82	Roller	300 (135)	2.9 (1.3)	2.5 (1.1)	03-PHR-5	04-PHR-5				

Optional Top Plates
 Add prefix **A** or **D** to caster number.
 Example: **A03-SRP-35**

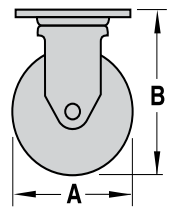
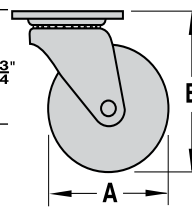
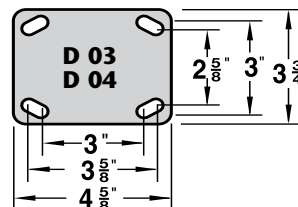
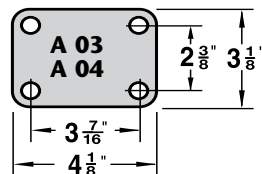

SERIES TM LIGHT MED DUTY THREADED STEM

Capacities to 290 lbs.

Standard Features

- Exceeds I.C.M. Standards
- **Load Bearing** - Two full independent rows of hardened and polished ball bearings
- **Stamped And Formed Construction**
- **All Metal Parts Are Stress Relieved**
- **Finish** - Corrosion resistant zinc
- **NSF Approved**

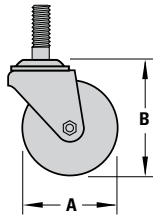

TM-SPB-5-12

Optional Features

- **Tread Contact Brake** - (Suffix -WB)
- **Stem Lengths** - Specific stem lengths cut and deburred to order
- **Thread Guards** - (Suffix -TG)
- **Grease Seals** - (Suffix -GS)
- **Rigid Casters Available**



Tread Contact Brake

Stem Selections

Threaded Stem Size Diameter & Length	Stem Suffix
7/16" - 14" x 1 1/2"	-72
7/16" - 14" x 2 1/8"	-78
1/2" - 13" x 1 1/2"	-12

Add the Stem Suffix to the swivel caster part number.

Example TM-SRP-3-12

Wheel Specifications					Caster Specifications				Part Number		
Dia. "A" Inches (mm)	Tread Inches (mm)	Wheel Composition	Ref. to Page	Bearing Type	Axle Dia. Inches (mm)	Load Capacity lbs. (KGS)	Overall Height "B" Inches (mm)	Swivel Radius Inches (mm)	Approx. Shipping Weight lbs. (KGS)	Caster	Stem Suffix
3 (76)	1 1/4 (32)	Soft Rubber	73	Self Lube	3/8 (10)	175 (79)	3 13/16 (97)	2 3/4 (70)	1.3 (.59)	TM-SRP-3...	-72, -12
		Hard Rubber	84	Self Lube		270 (130)			1.3 (.59)	TM-HRP-3...	
		Solid Urethane	77	Plain		270 (130)			1.3 (.59)	TM-KTP-3...	
		Santoprene	72	Ball		200 (90)			1.3 (.59)	TM-SPB-3...	
		Polyolefin (Blk)	81	Plain		270 (130)			1.3 (.59)	TM-PBP-3...	
		Polyolefin (Wt)	81	Plain		270 (130)			1.3 (.59)	TM-PWP-3...	
3 1/2 (89)	1 1/4 (32)	Soft Rubber	73	Self Lube	3/8 (10)	275 (124)	4 3/4 (121)	3 3/16 (81)	1.9 (.86)	TM-SRP-35...	-72, -78, -12
		Hard Rubber	84	Self Lube		200 (90)			1.9 (.86)	TM-HRP-35...	
	1 3/8 (35)	Santoprene (Polyolefin Core)	72	Ball		200 (90)			2.2 (1.0)	TM-SPB-35...	
		Polyurethane (Polyolefin Core)	72	Delrin		200 (90)			2.2 (1.0)	TM-SPD-35...	
		Polyurethane (Polyolefin Core)	80	Ball		275 (124)			2.2 (1.0)	TM-PBP-35...	
		Polyurethane (Polyolefin Core)	80	Delrin		275 (124)			2.2 (1.0)	TM-PPD-35...	
4 (102)	1 1/4 (32)	Soft Rubber	73	Self Lube	3/8 (10)	200 (90)	5 (127)	3 7/16 (87)	2.2 (1.0)	TM-SRP-4...	-72, -78, -12
		Hard Rubber	84	Self Lube		275 (124)			2.2 (1.0)	TM-HRP-4...	
		Solid Urethane	77	Plain		275 (124)			2.2 (1.0)	TM-KTP-4...	
	1 3/8 (35)	Santoprene (Polyolefin Core)	72	Ball		200 (90)			2.1 (.95)	TM-SPB-4...	
		Santoprene (Polyolefin Core)	72	Delrin		200 (90)			2.1 (.95)	TM-SPD-4...	
		Polyurethane (Polyolefin Core)	80	Ball		250 (113)			2.1 (.95)	TM-PBP-4...	
		Polyurethane (Polyolefin Core)	80	Delrin		250 (113)			2.1 (.95)	TM-PPD-4...	
		Polyolefin (Blk)	81	Plain		275 (124)			1.9 (.86)	TM-PBP-4...	
Polyolefin (Wt)	81	Plain	275 (124)	1.9 (.86)	TM-PWP-4...						
5 (127)	1 1/4 (32)	Soft Rubber	73	Self Lube	3/8 (10)	240 (104)	6 (152)	3 15/16 (99)	2.9 (1.3)	TM-SRP-5...	-72, -78, -12
		Hard Rubber	84	Self Lube		290 (131)			2.9 (1.3)	TM-HRP-5...	
		Solid Urethane	77	Plain		290 (131)			2.9 (1.3)	TM-KTP-5...	
	1 3/8 (35)	Santoprene (Polyolefin Core)	72	Ball		225 (101)			2.9 (1.3)	TM-SPB-5...	
		Santoprene (Polyolefin Core)	72	Delrin		225 (101)			2.9 (1.3)	TM-SPD-5...	
		Polyurethane (Polyolefin Core)	80	Ball		275 (124)			2.9 (1.3)	TM-PBP-5...	
		Polyurethane (Polyolefin Core)	80	Delrin		275 (124)			2.9 (1.3)	TM-PPD-5...	
		Polyolefin (Blk)	81	Plain		290 (131)			2.5 (1.13)	TM-PBP-5...	
Polyolefin (Wt)	81	Plain	290 (131)	2.5 (1.13)	TM-PWP-5...						
6 (152)	1 3/8 (35)	Santoprene (Polyolefin Core)	72	Ball	3/8 (10)	225 (101)	7 9/16 (192)	4 3/4 (121)	2.9 (1.3)	TM-SPB-6...	-72, -78, -12
		Santoprene (Polyolefin Core)	72	Delrin		225 (101)			2.9 (1.3)	TM-SPD-6...	
		Polyurethane (Polyolefin Core)	80	Ball		275 (124)			2.9 (1.3)	TM-PBP-6...	
		Polyurethane (Polyolefin Core)	80	Delrin		275 (124)			2.9 (1.3)	TM-PPD-6...	

SERIES G03 LIGHT MED DUTY GRIP RING

Capacities to 275 lbs.

Standard Features

- Exceeds ICM Standards
- Load Bearings - Two full independent rows of hardened and polished ball bearings

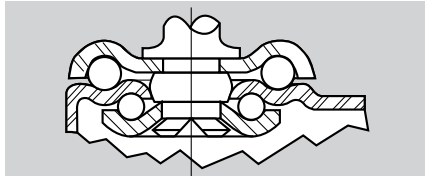

- Finish - Corrosion resistant zinc
- Stem Dimensions -

7/16" x 1 3/8"

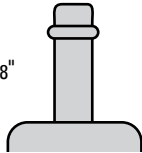

Optional Features

- Tread Contact Brake - (Suffix -WB)
- NSF Approved

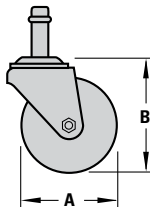

G03-KPT-5



APPLICATIONS:

This versatile caster is used in a variety of institutional, food service, and office equipment.

Stem and socket combinations for all standard tubing sizes. Additional sockets and brackets are shown on page 68.



Tread Contact Brake (Suffix -WB)

SOCKETS FOR STEM CASTERS

New Patented Reinforced Thermoplastic Design - Unlike plastic or steel, sockets will not loosen or wear.

Sockets for Round Tubing

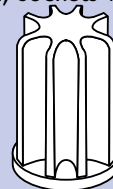

Socket #	Fits Round I.D. Tube
RD1	.777
RD2	.872
RD3	.894
RD9	.902
RD4	1.072
RD5	1.12
RD6	1.31
RD7	1.495

Sockets for Square Tubing

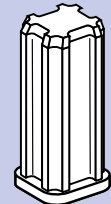

Socket #	Fits Square I.D. Tube
SQ1	.620
SQ2	.650
SQ3	.870
SQ4	.902
SQ5	1.101
SQ6	1.120
SQ7	1.140
SQ8	1.150
SQ9	1.152
SQ10	1.40

Wheel Specifications						Caster Specifications				Part Number
Dia. "A" Inches (mm)	Tread Inches (mm)	Wheel Composition	Ref. to Page	Bearing Type	Axle Dia. Inches (mm)	Load Capacity lbs. (KGS)	Height "B" Inches (mm)	Swivel Radius Inches (mm)	Approx. Shipping Weight lbs. (KGS)	Caster
3 (76)	1 1/4 (32)	Polyolefin	81	Plain	3/8 (10)	270 (121)	3 13/16 (97)	2 3/4 (70)	1.1 (.50)	G03-PBP-3
		Soft Rubber	73	Self Lube		175 (79)			1.4 (.63)	G03-SRP-3
		Solid-Urethane	77	Plain		290 (131)			1.5 (.68)	G03-KTP-3
	1 3/8 (35)	Santoprene (Polyolefin Core)	72	Ball		200 (90)			1.5 (.68)	G03-SPB-3
		Delrin	72	Delrin		200 (90)			1.5 (.68)	G03-SPD-3
		Polyurethane (Polyolefin Core)	80	Ball		250 (112)			1.5 (.68)	G03-PPB-3
		Delrin	80	Delrin		250 (112)			1.5 (.68)	G03-PPD-3
		4 (102)	1 1/4 (32)	Polyolefin		81			Plain	275 (124)
Soft Rubber	73			Self Lube	200 (90)	2.2 (1.0)	G03-SRP-4			
Solid-Urethane	77			Plain	290 (131)	2.2 (1.0)	G03-KTP-4			
1 3/8 (35)	Santoprene (Polyolefin Core)		72	Ball	200 (90)	2.1 (.95)	G03-SPB-4			
	Delrin		72	Delrin	200 (90)	2.1 (.95)	G03-SPD-4			
	Polyurethane (Polyolefin Core)		80	Ball	250 (112)	2.1 (.95)	G03-PPB-4			
	Delrin		80	Delrin	250 (112)	2.1 (.95)	G03-PPD-4			
	5 (127)		1 1/4 (32)	Polyolefin	81	Plain	275 (124)	3/8 (10)	6 1/8 (156)	3 15/16 (100)
Soft Rubber		73		Self Lube	200 (90)	2.9 (1.3)	G03-SRP-5			
Solid-Urethane		77		Plain	300 (135)	2.9 (1.3)	G03-KTP-5			
1 3/8 (35)		Santoprene (Polyolefin Core)	72	Ball	225 (101)	2.9 (1.3)	G03-SPB-5			
		Delrin	72	Delrin	225 (101)	2.9 (1.3)	G03-SPD-5			
		Polyurethane (Polyolefin Core)	80	Ball	275 (124)	2.9 (1.3)	G03-PPB-5			
		Delrin	80	Delrin	275 (124)	2.9 (1.3)	G03-PPD-5			

SERIES XM LIGHT MED DUTY EXPAND. STEM

Capacities to 300 lbs.

Standard Features

- 3 Piece Polypropylene Socket Expands Into Tubing
- Exceeds I.C.M. Standards
- Load Bearing - Two full independent rows of hardened and polished ball bearings
- Stamped And Forme Construction
- All Metal Parts Are Stress Relieved
- Finish - Corrosion resistant zinc

Optional Features

- Tread Contact Brake - (Suffix -WB)
- Grease Seals - (Suffix -GS)
- Thread Guards - (Suffix -TG)
- Available In Stainless Steel
- NSF Approved

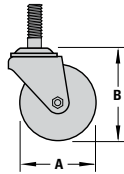

XM-SPB-5-150



Tread Contact Brake

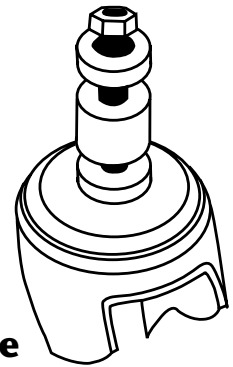

Expandable Stem Selections

Inside Diameter of Tubing	Stem Suffix
3/4" - 15/16" Round or Square	-100
1" - 1 3/16" Round or Square	-125
1 1/4" - 1 1/2" Round or Square	-150
1 9/16" - 1 3/4" Round or Square	-175

Add the Stem Code Suffix to the swivel caster part number.

Example XM-SRP-35-100

Wheel Specifications					Caster Specifications					Part Number	
Dia. "A" Inches (mm)	Tread Inches (mm)	Wheel Composition	Ref. to Page	Bearing Type	Axle Dia. Inches (mm)	Load Capacity lbs. (KGS)	Overall Height "B" Inches (mm)	Swivel Radius Inches (mm)	Approx. Shipping Weight lbs. (KGS)	Caster	Stem Suffix
3 1/2 (89)	1 5/16 (33)	Soft Rubber	73	Self Lube	3/8 (10)	200 (90)	4 3/4 (121)	3 3/16 (81)	1.9 (.86)	XM-SRP-35 . . .	-100, -125, -150, -175
	1 1/8 (29)	Rubber Tire (Steel Disc)	N/A	Ball		200 (90)			2.2 (1.0)	XM-RTB-35 . . .	
	1 3/8 (35)	Santoprene (Polyolefin Core)	72	Ball		200 (90)			1.6 (.72)	XM-SPB-35 . . .	
			72	Delrin		200 (90)			1.6 (.72)	XM-SPD-35 . . .	
		Polyurethane (Polyolefin Core)	80	Ball		225 (101)			1.6 (.72)	XM-PPB-35 . . .	
			80	Delrin		225 (101)			1.6 (.72)	XM-PPD-35 . . .	
4 (102)	1 1/4 (32)	Soft Rubber	73	Self Lube	3/8 (10)	200 (90)	5 (127)	3 7/8 (87)	2.2 (1.0)	XM-SRP-4 . . .	-100, -125, -150, -175
	1 1/8 (29)	Rubber Tire (Steel Disc)	N/A	Ball		200 (90)			2.4 (1.0)	XM-RTB-4 . . .	
	1 3/8 (35)	Solid Urethane	77	Plain		275 (124)			1.9 (.86)	XM-KTP-4 . . .	
			72	Ball		200 (90)			2.7 (1.2)	XM-SPB-4 . . .	
		Polyurethane (Polyolefin Core)	72	Delrin		200 (90)			2.7 (1.2)	XM-SPD-4 . . .	
			80	Ball		250 (112)			2.7 (1.2)	XM-PPB-4 . . .	
			80	Delrin		250 (112)			2.7 (1.2)	XM-PPD-4 . . .	
			5 (127)	1 1/4 (32)		Soft Rubber			73	Self Lube	
1 1/8 (29)	Rubber Tire (Steel Disc)	N/A		Ball	240 (108)	3.0 (1.4)	XM-RTB-5 . . .				
1 3/8 (35)	Solid Urethane	77		Plain	300 (135)	3.1 (1.4)	XM-KTP-5 . . .				
		72		Ball	225 (101)	3.6 (1.6)	XM-SPB-5 . . .				
	Polyurethane (Polyolefin Core)	72		Delrin	225 (101)	3.6 (1.6)	XM-SPD-5 . . .				
		80		Ball	275 (124)	3.6 (1.6)	XM-PPB-5 . . .				
80	Delrin	275 (124)	3.6 (1.6)	XM-PPD-5 . . .							
6 (152)	1 3/8 (35)	Santoprene (Polyolefin Core)	72	Ball	3/8 (10)	250 (112)	7 9/16 (192)	4 7/8 (124)	4.0 (1.8)	XM-SPB-6 . . .	-100, -125, -150, -175
		Polyurethane (Polyolefin Core)	72	Delrin		250 (112)			4.0 (1.8)	XM-SPD-6 . . .	
			80	Ball		250 (112)			4.0 (1.8)	XM-PPB-6 . . .	
			80	Delrin		250 (112)			4.0 (1.6)	XM-PPD-6 . . .	
			80	Delrin		250 (112)			4.0 (1.6)	XM-PPD-6 . . .	

SERIES CL LIGHT MED DUTY COMPLETE LOCK

Capacities to 300 lbs.

Standard Features

- **Complete Locking Mechanism** - Locks both the wheel and the swivel
- **Load Bearings** - Two full independent rows of ball bearings
- **Wheel Bearings** - Are totally sealed
- **Dust Shields** - Upper and lower race

Optional Features

- **Expandable Socket Adapters**
- **Hollow King Pin** (Swivel Only) - Allows for special length bolt to be inserted through open hole in swivel assembly.
- **Swivel without Lock** (Prefix **CLS**)

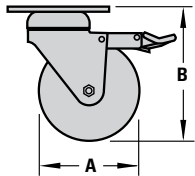

CL-SPB-5



CLR-PPB-4

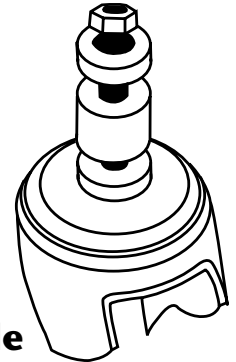

Expandable Stem Selections

Inside Diameter of Tubing	Stem Suffix
3/4" - 15/16" Round or Square	-100
1" - 1 3/16" Round or Square	-125
1 1/4" - 1 1/2" Round or Square	-150
1 9/16" - 1 3/4" Round or Square	-175

Add Expansion Stem Suffix to the swivel part number.

Example CL-SRP-35-**100**

Standard Top Plate

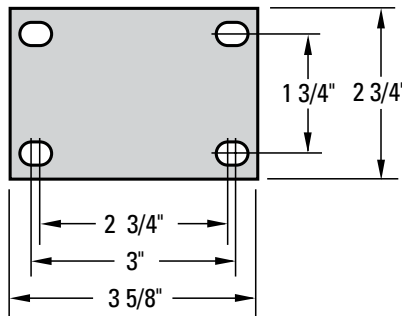

Wheel Specifications					Caster Specifications					Part Number		
Dia. "A" Inches (mm)	Tread Inches (mm)	Wheel Composition	Ref. to Page	Bearing Type	Axle Dia. Inches (mm)	Load Capacity lbs. (KGS)	Overall Height "B" Inches (mm)	Swivel Radius Inches (mm)	Attach. Bolt Inches (mm)	Approx. Shipping Weight lbs. (KGS)	Swivel Complete Lock	Rigid
3 1/2 (89)	1 3/8 (35)	Soft Rubber	73	Self Lube	3/8 (10)	200 (90)	4 29/32 (124)	2 21/32 (74)	5/16 (8)	1.9 (.9)	CL-SRP-35	CLR-SRP-35
		Santoprene (Polyolefin Core)	72	Ball		200 (90)				1.8 (.8)	CL-SPB-35	CLR-SPB-35
			72	Delrin		200 (90)				1.8 (.8)	CL-SPD-35	CLR-SPD-35
		Polyurethane (Polyolefin Core)	80	Ball		250 (112)				1.8 (.8)	CL-PPB-35	CLR-PPB-35
			80	Delrin		250 (112)				1.8 (.8)	CL-PPD-35	CLR-PPD-35
4 (102)	1 3/8 (35)	Soft Rubber	73	Self Lube	3/8 (10)	200 (90)	5 9/16 (141)	3 7/32 (82)	5/16 (8)	2.2 (1.0)	CL-SRP-4	CLR-SRP-4
		Santoprene (Polyolefin Core)	72	Ball		200 (90)				2.1 (.9)	CL-SPB-4	CLR-SPB-4
			72	Delrin		200 (90)				2.1 (.9)	CL-SPD-4	CLR-SPD-4
		Polyurethane (Polyolefin Core)	80	Ball		250 (112)				2.1 (.9)	CL-PPB-4	CLR-PPB-4
			80	Delrin		250 (112)				2.1 (.9)	CL-PPD-4	CLR-PPD-4
	1 1/4 (32)	Solid Urethane	77	Plain	275 (124)	2.1 (.9)	CL-KTP-4	CLR-KTP-4				
5 (125)	1 3/8 (35)	Soft Rubber	73	Self Lube	3/8 (10)	200 (90)	6 1/2 (165)	3 23/32 (95)	5/16 (8)	2.9 (1.3)	CL-SRP-5	CLR-SRP-5
		Santoprene (Polyolefin Core)	72	Ball		225 (101)				2.9 (1.3)	CL-SPB-5	CLR-SPB-5
			72	Delrin		225 (101)				2.9 (1.3)	CL-SPD-5	CLR-SPD-5
		Polyurethane (Polyolefin Core)	80	Ball		275 (124)				2.9 (1.3)	CL-PPB-5	CLR-PPB-5
			80	Delrin		275 (124)				2.9 (1.3)	CL-PPD-5	CLR-PPD-5
	1 1/4 (32)	Solid Urethane	77	Plain	300 (135)	2.9 (1.3)	CL-KTP-5	CLR-KTP-5				

SERIES 05/06 LIGHT MEDIUM DUTY DELUXE

Capacities to 400 lbs.

Standard Features

- **Highest Capacity Rating** - For a Light Medium Duty Caster
- **Load Bearings** - Two independent rows of ball bearings in over-sized, shielded raceways
- **Thread Guards** - On Advanced Elastomer and Neoprene wheels
- **Finish** - Corrosion resistant zinc

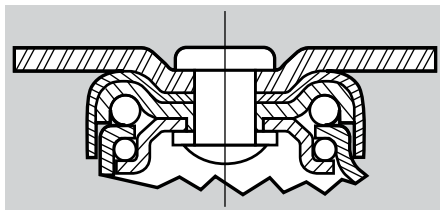

Optional Features

- **Wheel Brakes** - (Suffix **-WB**)
- **Conductive Wheels** - Advanced Elastomer & Neoprene (Suffix **-CDX**)
- **Anti-Static Wheels** (Please inquire)
- **Swivel Lock** - (Suffix **-SL**)

Threaded Stem Selections

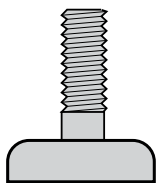

Threaded Stem Size Diameter & Length	Stem Suffix
1/2" x 1 1/2" NC	-TH
5/8" x 2" NC	-TN
3/4" x 2 1/2" NC	-TR

Add the Stem Suffix to the swivel caster part number.

Example 05-NPB-35-**TN**

Grip Ring Stem Selections

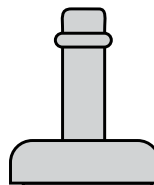

Grip Ring Stem Size Diameter & Length	Stem Suffix
5/8" x 2"	-GU
7/8" x 2"	-GF
1" x 2 1/2"	-GK

APPLICATIONS:

Equipment crates and cases where constant loading and unloading require superior performance.

Professional movers dollies are subjected to abuse beyond the normal application. Like any good tool, the investment in quality is worthwhile.



05-AEB-4



Rigid Caster
06-AEB-4

Top Plate Dimensions & Mounting Hole Spacing

Size of Top Plate (Inches) (mm)	Mounting Hole Spacing (Inches) (mm)	Plate Suffix
3 5/8 x 2 1/2 (92 x 63.5)	3 x 1 3/4 (76 x 44)	Standard
4 3/8 x 3 3/8 (111 x 86)	3 3/8 x 2 3/8 (86 x 60)	P3
4 x 4 (102 x 102)	3 x 3 (76 x 76)	P4

Wheel Specifications						Caster Specifications						Part Number	
Dia. "A" Inches (mm)	Tread Inches (mm)	Wheel Composition	Ref. to Page	Bearing Type	Axle Dia. Inches (mm)	Load Capacity lbs. (KGS)	Overall Height "B" Inches (mm)	Swivel Radius Inches (mm)	Attach. Bolt Inches (mm)	Approx. Shipping Wt.		Swivel Caster	Rigid Caster
										Swivel lbs. (KGS)	Rigid lbs. (KGS)		
3 (75)	1 1/4 (32)	Advanced Elastomer	76	Ball	3/8 (10)	400 (180)	4 5/16 (109)	2 3/4 (70)	5/16 (8)	2.25 (1.0)	2.0 (.90)	05-AEB-3	06-AEB-3
		Neoprene	N/A	Ball		200 (90)				2.25 (1.0)	2.0 (.90)	05-NPB-3	06-NPB-3
		Phenolic	82	Roller		400 (180)				2.25 (1.0)	2.0 (.90)	05-PHR-3	06-PHR-3
	1 3/8 (35)	Polyurethane (Polyolefin Core)	80	Ball		250 (250)				2.25 (1.0)	2.0 (.90)	05-PPB-3	06-PPB-3
3 1/2 (89)	1 1/4 (32)	Advanced Elastomer	76	Ball	3/8 (10)	400 (180)	4 3/4 (121)	3 (75)	5/16 (8)	3.0 (1.4)	2.5 (1.2)	05-AEB-35	06-AEB-35
		Neoprene	N/A	Ball		200 (90)				3.0 (1.4)	2.5 (1.2)	05-NPB-35	06-NPB-35
		Phenolic	82	Roller		400 (180)				3.0 (1.4)	2.5 (1.2)	05-PHR-35	06-PHR-35
	1 3/8 (35)	Polyurethane (Polyolefin Core)	80	Ball		360 (164)				3.0 (1.4)	2.5 (1.2)	05-PPB-35	06-PPB-35
4 (102)	1 1/4 (32)	Advanced Elastomer	76	Ball	3/8 (10)	400 (180)	5 1/4 (133)	3 1/4 (83)	5/16 (8)	3.2 (1.4)	2.7 (1.2)	05-AEB-4	06-AEB-4
		Neoprene	N/A	Ball		200 (90)				3.2 (1.4)	2.7 (1.2)	05-NPB-4	06-NPB-4
		Phenolic	82	Roller		400 (180)				3.2 (1.4)	2.7 (1.2)	05-PHR-4	06-PHR-4
	1 3/8 (35)	Polyurethane (Polyolefin Core)	80	Ball		400 (182)				3.2 (1.4)	2.7 (1.2)	05-PPB-4	06-PPB-4
5 (127)	1 1/4 (32)	Advanced Elastomer	76	Ball	3/8 (10)	400 (180)	6 1/4 (159)	4 3/4 (121)	5/16 (8)	3.5 (1.6)	3.0 (1.4)	05-AEB-5	06-AEB-5
		Neoprene	N/A	Ball		200 (90)				3.5 (1.6)	3.0 (1.4)	05-NPB-5	06-NPB-5
		Phenolic	82	Roller		400 (180)				3.5 (1.6)	3.0 (1.4)	05-PHR-5	06-PHR-5
	1 3/8 (35)	Polyurethane (Polyolefin Core)	80	Ball		400 (182)				3.5 (1.6)	3.0 (1.4)	05-PPB-5	06-PPB-5

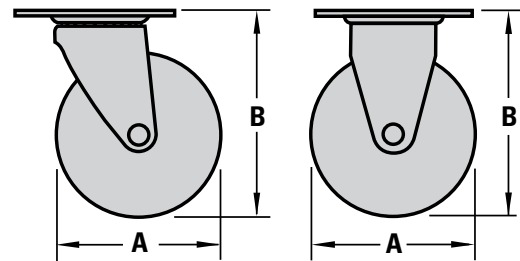

Standard Top Plate

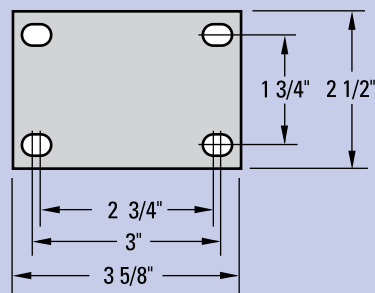

HOLES FOR 5/16" BOLTS

Rigid Top Plate

Optional Top Plates

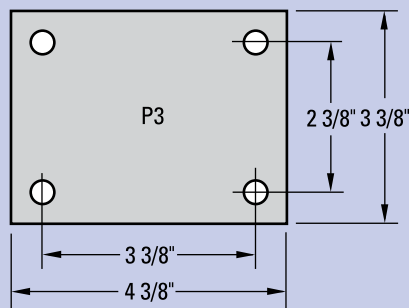

HOLES FOR 3/8" BOLTS

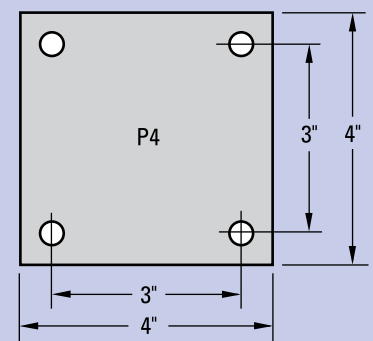

HOLES FOR 3/8" BOLTS

Add the Plate Suffix to the caster part number.

Example 05-NPB-4-**P3**