

BUMPERS

Corner and Strip Bumpers

CSB-12 CORNER BUMPERS

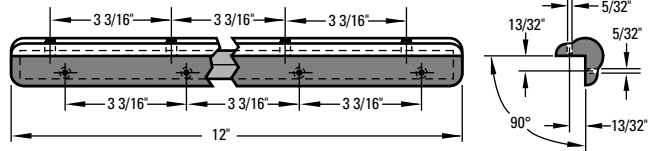

A molded strip corner bumper 12" long, for application to any right angle shape. Easily installed with self tapping metal screws. Weight = 8 oz. each. Part No. **CSB-12**

HDDTSB DESK TOP

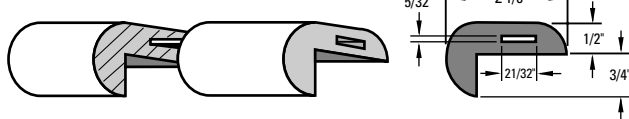

Provides excellent protection for desk and table edges, etc. Max. lengths 16 ft. for easy installation. Metal insert optional. Weight = 14 oz./ft. Part No. **HDDTSB**

LDSTSB FLAT BASED RUBBER STRIP

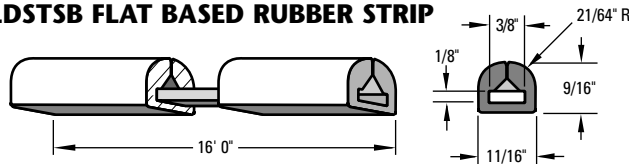

A flat-based rubber strip bumper, with split top for easier installation. Metal insert optional. Weight = 4 oz./ft. Part No. **LDSTSB**

LDSB STRIP BUMPERS

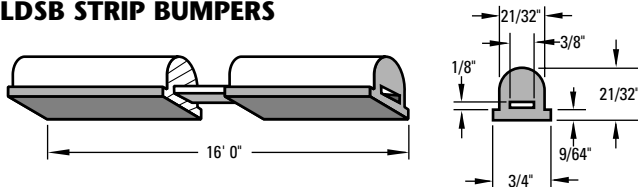

A very popular small-sized strip bumper is adaptable to many applications. This model is easily applied to equipment. Metal insert optional. Weight = 4 oz./ft. Part No. **LDSB**

HDCMSB 1" CHANNEL IRON

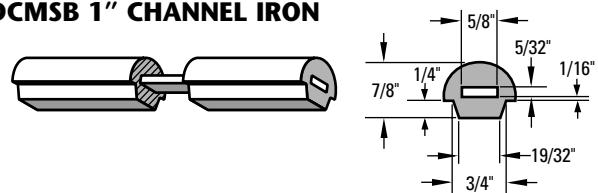

Used with 1" Commercial Channel Iron, but is designed for lighter service, eliminating unnecessary weight. Metal insert optional. Weight 9 Oz./ft. Part No. **HDCMSB**

LDCMSB 1 1/4" CHANNEL IRON

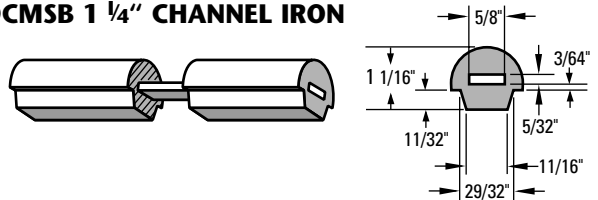

Made for 1 1/4" Commercial Channel Iron. Used with heavier equipment where strength is necessary for operation. Metal insert optional. Weight = 12 oz./ft. Part No. **LDCMSB**

HDSTSB FLAT RUBBER STRIP BUMPERS

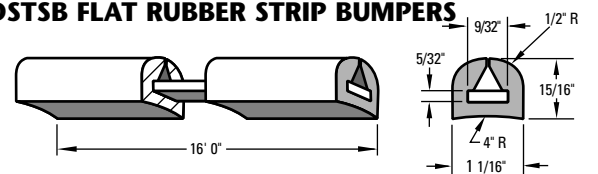

A flat based rubber strip bumper designed for same use as HDSB. With split top for easier installation. Metal insert optional. Weight = 9 oz./ft. Part No. **HDSTSB**

HDSB FLAT BASED RUBBER STRIP

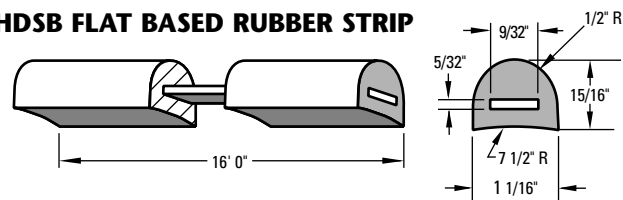

Designed for installation on metal or wood surfaces. This model is easily applied and does not require a special channel. Metal insert is optional. Weight = 9 oz./ft. Part No. **HDSB**

CB1 CORNER BUMPERS

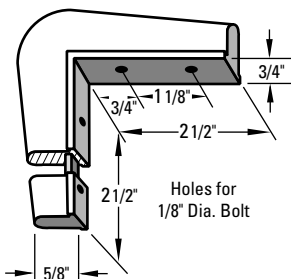

Made especially for use with **LDSB** Strip Bumper, giving a uniform continuous effect all around the equipment. Weight = 5 oz. each. Part No. **CB 1**

CB2 CORNER BUMPERS

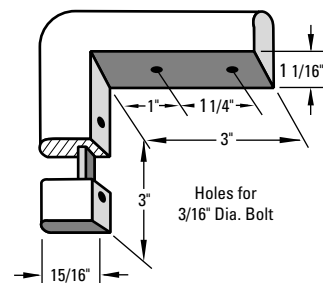

Made especially for use with **HDSB** Strip Bumper, giving a uniform continuous effect all around the equipment. Weight = 5 oz. each. Part No. **CB 2**

CB3 HEAVY DUTY CORNER BUMPERS

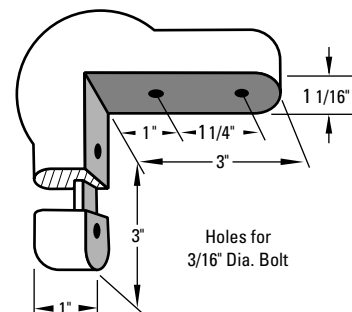

Gives protection to all surfaces contacted, like doors, walls, furniture and equipment. Attach with self-tapping sheet metal screws. Weight = 6 oz. each. Part No. **CB 3**

BUMPERS

Tubeing & Doughnut Bumpers

DOUGHNUT BUMPERS

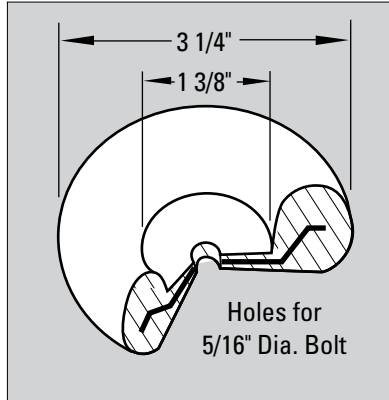

Commonly installed on the ends of tubular handles to give needed protection in manipulation of equipment. Note steel insert. Attached to wood with wood screws or to metal with rivets, bolts or metal screws.

Weight 6 oz. each. Part No. **DB1**

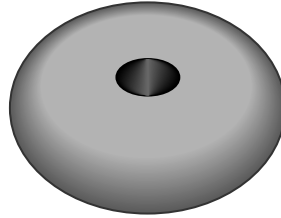

Round Tubing Bumper

3" Outside Diameter	Part Number
5/8" Dia. I.D.	RTB1048
3/4" Dia. I.D.	RTB1248
7/8" Dia. I.D.	RTB1448
1" Dia. I.D.	RTB1648
1 1/4" Dia. I.D.	RTB2048

Weight = 3 oz. each

5" Outside Diameter	Part Number
1" Dia. I.D.	RTB1680
1 1/4" Dia. I.D.	RTB2080
1 1/2" Dia. I.D.	RTB2480
1.9" Dia. I.D.	RTB3180

Weight = 12 oz. each

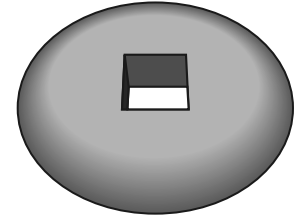

Square Tubing Bumper

3" Outside Diameter	Part Number
7/8" Square I.D.	STB1448
1" Square I.D.	STB1648

Weight = 4 oz. each

5" Outside Diameter	Part Number
1" Square I.D.	STB1680
1 1/4" Square I.D.	STB2080
1 1/2" Square I.D.	STB2480
1 5/8" Square I.D.	STB2680
1 3/4" Square I.D.	STB2880
2" Square I.D.	STB3280

Weight = 12 oz. each

REVOLVING & MOLD-ON RUBBER BUMPERS

Application:
Used with Stem Casters

Stem Size Selection

Stem Size Dia.	Suffix
7/16"	-1
1/2"	-2
9/16"	-3
5/8"	-4
3/4"	-5
13/16"	-6
7/8"	-7
2"	-8

Add the Stem Suffix to the mold-on bumper part number.

Example- MHDRB-64-1



REVOLVING BUMPERS

Designed to fit on a caster stem to prevent a bed, equipment or furniture from striking the wall. The bumper revolves, thus eliminating any chance of smearing the wall or causing an erasure. Made from grey non-marking rubber.

Note: This bumper only available for 7/16" or 5/8". Diameter stem.

Revolving Bumpers

Dia.	Face Width	Inside Dia.	Part Number
3"	3/8"	7/16"	RB748
	3/8"	5/8"	RB1048
4"	3/8"	7/16"	RB764
	3/8"	5/8"	RB1064
5"	1/2"	7/16"	RB780
	1/2"	5/8"	RB1080

Weight = 6 oz. ea

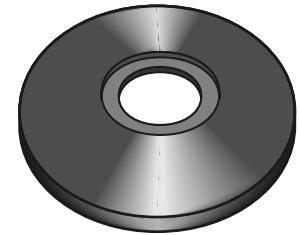

MOLD-ON HEAVY DUTY RUBBER BUMPERS

Virtually indestructible and long lasting, these solid rubber bumpers fit almost every type of portable equipment requiring heavy duty bumpers. Made of grey (non-marking) rubber molded around a heavy steel insert. Machine steel hubs are made standard for stem sizes: 7/16", 1/2", 9/16", 5/8", 3/4", 13/16", 7/8", and 1". Other sizes available on request.

Rubber Bumpers

Dia.	Weight	Part Number
4"	8 oz.	MHDRB-64
5"	16 oz.	MHDRB-80
7"	24 oz.	MHDRB-112
7 1/2"	24 oz.	MHDRB-120
8 1/2"	32 oz.	MHDRB-136